



WASHINGTON
NATIONAL
TRANSIT
ORIENTED
DEVELOPMENT
DISTRICT
STREETSCAPE
PLAN

FEBRUARY 2016

AHBE

CONTENTS

SECTION 1 INTRODUCTION & VISION

Table of Contents and Consultant Team 2
 Plan Area and Introduction 3
 Overall Street Tree Diagram 5

SECTION 2 STREETScape PLAN

Common Design Elements 6
 Washington Boulevard 8
 Streetscape Plan 14
 Details 18
 Venice Boulevard 22
 Streetscape Plan 24
 Details 26
 National and Robertson Boulevards 30
 Streetscape Plan 32
 Details 36
 Wesley Street 38
 Streetscape Plan 40
 Details 41

SECTION 3 SIGNAGE

District Identify Logo designs 42
 District Banner, Pedestrian Directory
 and Directory Designs 43

SECTION 4 COST ESTIMATE

Preliminary Statement
 of Potential Project Budget 44

APPENDIX

Geotechnical Engineering
 Investigation Report 47
 Existing Conditions and Assessment and
 Opportunities Memo 68
 Material Cut Sheets 78



CLIENT

City of Culver City
 Community Development Department
 9770 Culver Boulevard
 Culver City, California 90232
 Contact: Mr. Sol Blumenfeld
 T 310.253.5702
 sol.blumenfeld@culvercity.org

PRIME CONSULTANT

AHBE Landscape Architects
 617 West Seventh Street, Suite 304
 Los Angeles, California 90017
 Contact: Mr. Evan Mather, ASLA
 T 213.694.3800
 emather@ahbe.com

CIVIL ENGINEERING

KOA Corporation
 1100 Corporate Center Drive, Suite 201
 Monterey Park, California 91754
 Contact: Mr. Stephen Bise, PE
 T 323.260.4703
 sbise@koacorp.com

SIGNAGE & GRAPHICS

Linespace
 8440 Warner Drive, Suite A1
 Culver City, California 90232
 Contact: Mr. Nicholas Groh
 T 310.581.4400
 ngroh@linespace.com

GEOTECHNICAL ENGINEERING

Geotechnologies, Inc.
 439 Western Avenue
 Glendale, California 91201
 Contact: Mr. Mike Savage
 T 818.240.9600
 msavage@geoteq.com

SURVEYING

KDM Meridian
 22541 Aspan Street, Suite C
 Lake Forest, California 92630
 Contact: Mr. Steve Runels
 T 949.768.0731
 srunels@kdmmeridian.com



PLAN AREA

INTRODUCTION

The purpose of this *Washington National Transit Oriented Development District Streetscape Plan* is to create a series of principles to guide the streetscape design in the vicinity of the Culver City Expo Line Station, and within an emerging Transit Oriented Development (TOD) district.

Spurred by the arrival of the Exposition Light Rail Line (Expo) from Downtown Los Angeles to Culver City in Spring of 2012, a series of new TODs are being planned and constructed near the intersection of Washington and National Boulevards. Phase II Expo Line is currently being extended to Santa Monica with service anticipated to commence in 2016.

These projects include *Access Culver City*, a 115-unit mixed use development by Greystar Real Estate; *Platform* at Culver Station by the Runyon Group; and *The Ivy Station* by Lowe Enterprise Real Estate Group adjacent to the Expo Culver City station. These new developments require common area public improvements to form a cohesive and attractive pedestrian environment within the *Washington National Transit Oriented Development District*.

The plan is intended to promote area revitalization through implementation of pedestrian friendly streetscape enhancements including canopy street trees, street furniture, graphics, new crosswalk paving and Low Impact Development (LID) features such as bioswales and filtration planters.

The plan comports with the *Bicycle Pedestrian Master Plan* that was approved by the City Council in 2010 and promotes multi-mobility, connectivity, and sustainability.

THIS PAGE INTENTIONALLY LEFT BLANK

OVERALL STREET TREE DIAGRAM

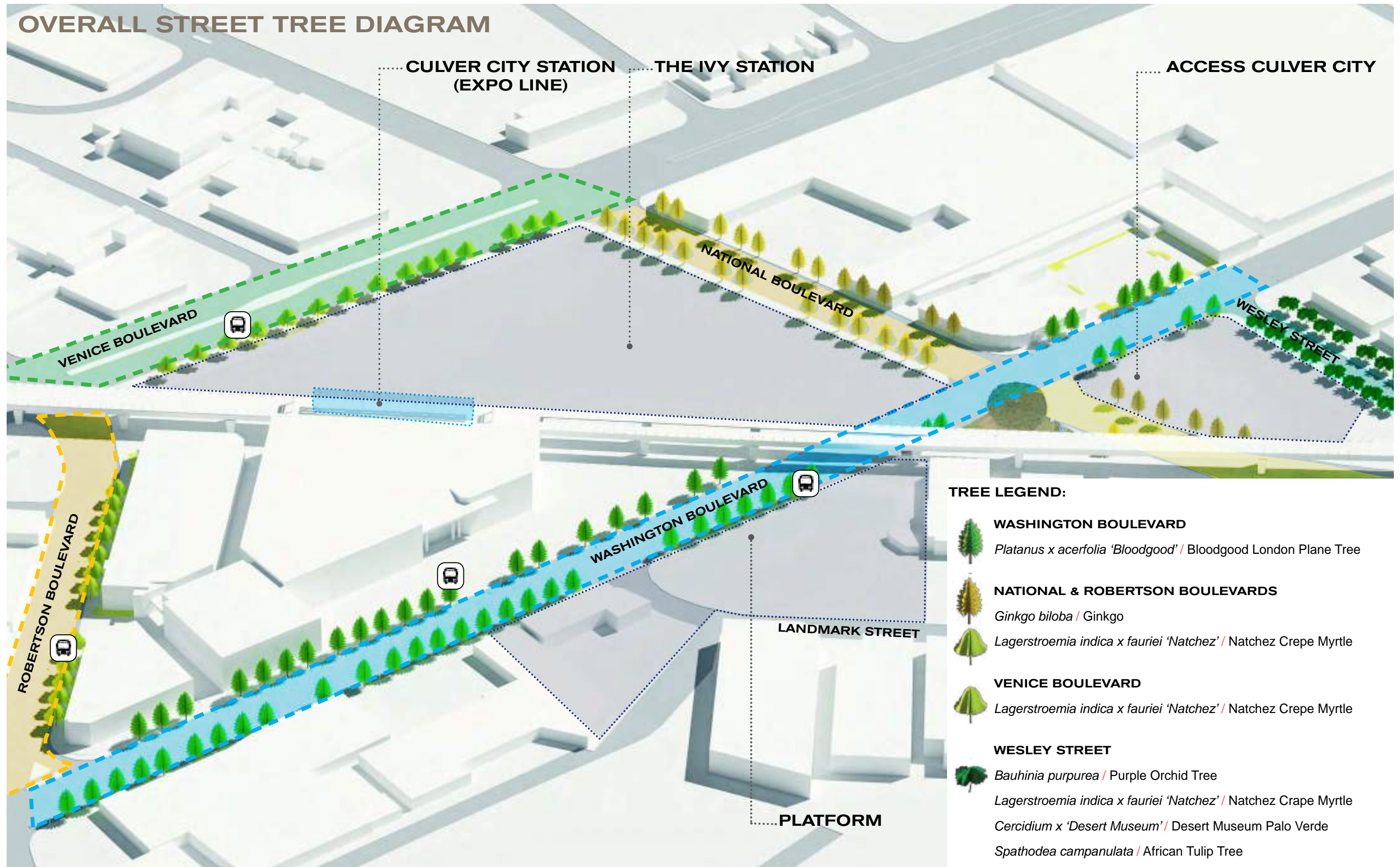

COMMON DESIGN ELEMENTS



"Towne Square" Bench by Landscape Forms



Silva Cells by Deep Root



4" x 24" Concrete Unit Plank Pavers



4" x 8" Permeable Concrete Unit Pavers



"Scarborough" Trash / Recyclables Receptacle by Landscape Forms



"Market Street" Tree Grate by Ironsmith



Concrete Pavement (Natural Gray Top-Cast, Finish #5)



"Simple-Lok" by Sunshine U-LOK Corporation

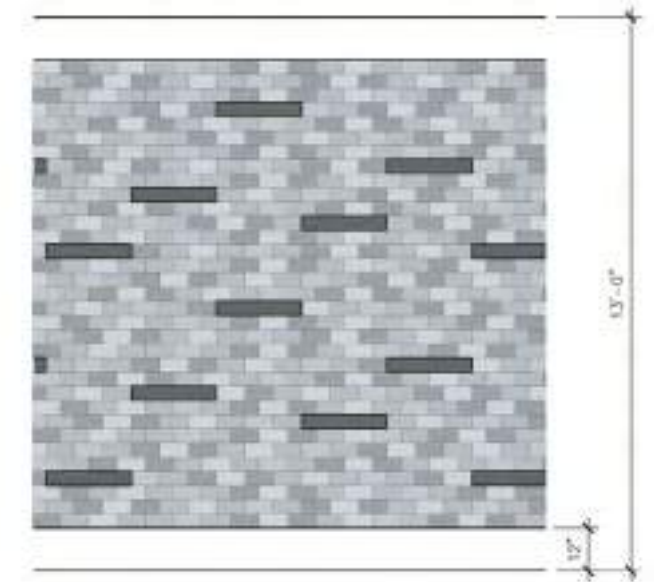

Standard Paver Running Bond Pattern

In order to visually unify the *Washington National Transit Oriented Development District*, consistent paving, street furniture, graphic signage, and LID technologies will be used throughout.

Canopy shade trees will be located at regular spacing along the streetscape. Intermittent bands of low planting will occur between the street trees.

Paving will be primarily a natural color concrete with a surface finish (*Top-Cast* by Dayton Superior). Bands and fields of *Aqua-via* (City Blend mix) concrete paver units and 4x16 (Charcoal) linear paving stones by Acker-Stone will distinguish the LID features and add a rich character to unify the district; 4x8 unit pavers will distinguish the crosswalks in a running bond pattern.

A new interpretive signage/environmental graphics program with the Culver City logo will provide information and way-finding and unify the district. This will consist primarily of district banners on existing light poles, way-finding signs and directories. Per TOD stakeholders' input, it is recommended that the transit district be referred to as *The Hub*. Proposed graphics have been developed to highlight and promote multi-mobility within the district.

At designated areas, seat nodes will be located adjacent to the street trees. The standard bench to be used throughout the district is the *Town Square* bench by Landscape Forms (49" length with interim divider to discourage sleeping). Accompanying the benches will be *Scarborough* trash/recyclables receptacles by Landscape Forms (24" diameter) and a pair of bike racks (*Simple-Lok* by Sunshine U-Lok Corporation).

The primary LID features will be concrete filtration planters and structural soil systems. The planters will filter storm water via a soil medium prior to discharge into the city storm water system. (Note:

the accompanying geotechnical investigation confirms that *infiltration* of storm water is not recommended.)

Decorative lighting, such as colored or patterned lighting of the columns and underside of the bridge of the Expo Line overpass, will highlight this distinct architectural feature.

The structured soil system (*Silva Cell* by Deep Root) provides for planting soil cells under the sidewalk and adjacent to the street trees to allow for greater root volume and therefore larger tree canopies. Street trees at the filtration planter will have tree grates (*Market Street* by Ironsmith and *Grate Stakes* by JR Partners). The tree grates will be finished with a rust inhibitor product (i.e. *Black Max*) to expedite to oxidation process and mitigate corrosion. Tree grate openings can be cut to make a larger area for the trunk as the trees mature.

WASHINGTON BOULEVARD



Platanus x acerfolia 'Bloodgood' / London Plane Tree



Lomandra longifolia 'Breeze' / Breeze Lomandra

The spine of the *Washington National Transit Oriented Development District Streetscape Plan* is Washington Boulevard itself, connecting the Helms Bakery complex to Downtown Culver City. Adjacent land uses are mainly commercial. The area of Washington National presents the opportunity for a gateway. The gateway design could include: public art piece, special landscape and/or special lighting treatment. The Plan recommends that special lighting be used to illuminate the train platform with color or *gobos* (i.e. shapes/patterns projected on the light) and/or special lighting at the intersection (four corners) at Washington Boulevard and National Boulevard. In addition, lighting could be used to illuminate special landscaping at the intersection as a gateway treatment.

The designated street tree will be a single row of deciduous, upright London Plane trees (Bloodgood cultivar) planted approximately every 30 feet. The London Plane Tree is an ideal street tree because it grows moderately quickly, is easily pruned, and is deciduous providing leafy shade during the hot summer months. When mature, these trees will provide a large canopy and a stronger visual connection along the wide boulevard. 'Breeze' Lomandra will be the primary ground cover plant. Decorative plank pavers and filtration planters will occur at each street tree.

New decorative crosswalks on Washington Boulevard (at Wesley Street, Landmark Street, and National Boulevard) will enhance the district. These crosswalks will be constructed of pavers in shades of gray in a running bond pattern (See Page 6).



VIEW LOOKING WEST ON WASHINGTON BOULEVARD



VIEW LOOKING EAST ON WASHINGTON BOULEVARD



VIEW LOOKING EAST ON WASHINGTON BOULEVARD NEAR ROBERTSON



VIEW LOOKING WEST ON WASHINGTON BOULEVARD / NIGHT

THIS PAGE INTENTIONALLY LEFT BLANK

STREETScape PLAN

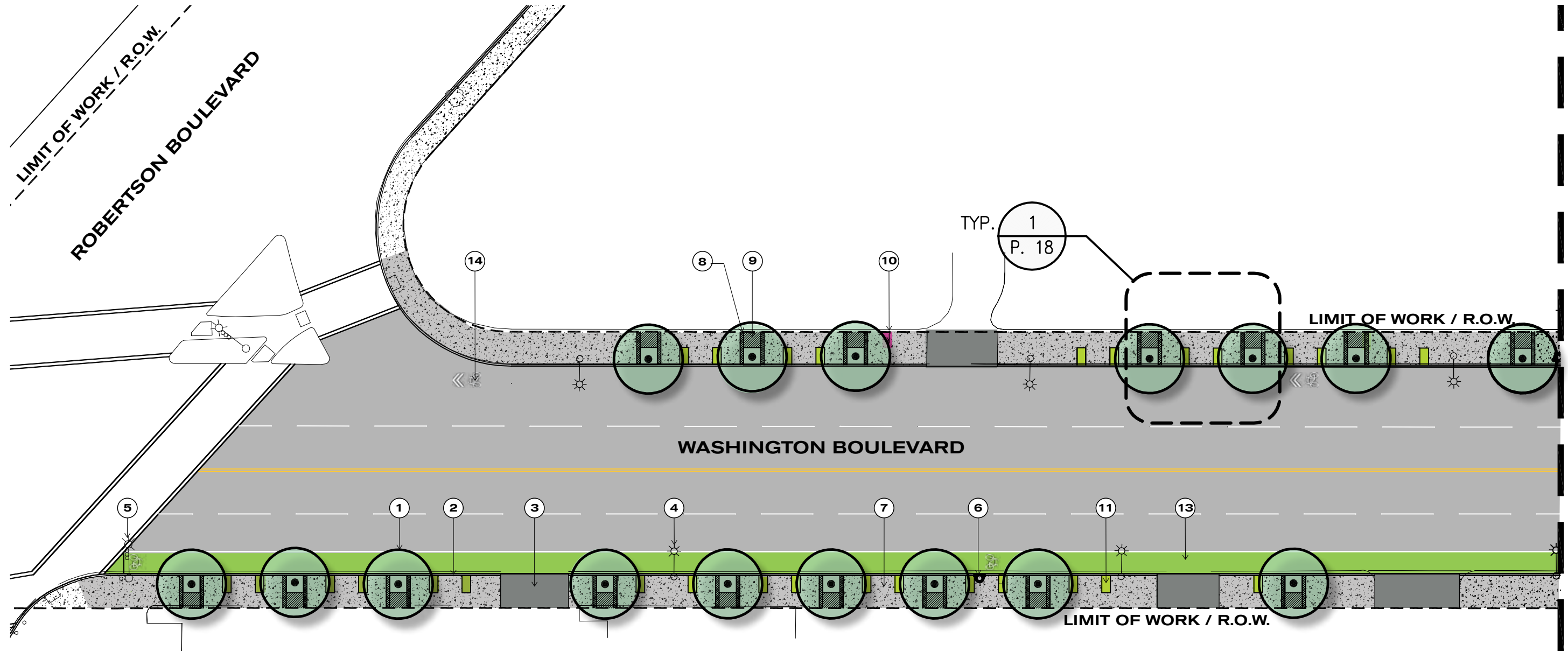

MATCHLINE, SEE PAGE 15

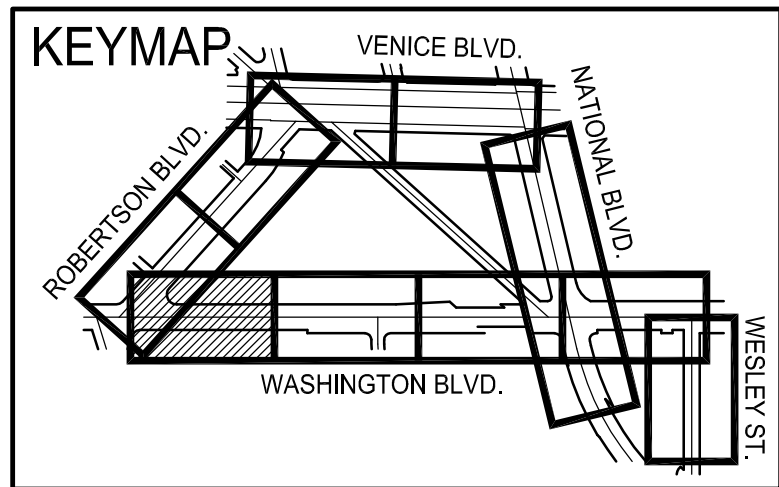

Washington Boulevard Keynote

- ① *Platanus x acerfolia* 'Bloodgood' / London Plane Tree
- ② Existing Tree To Be Removed
- ③ Existing Driveway To Remain
- ④ Existing Street Light to Remain
- ⑤ Existing Traffic Signal to Remain
- ⑥ Existing Fire Hydrant
- ⑦ New Concrete Paving
- ⑧ New Concrete Plank Pavers
- ⑨ New Permeable Pavers
- ⑩ New Pedestrian Directional Signage
- ⑪ New Planting Band
- ⑫ New Crosswalk Pavers
- ⑬ New Bike Lane
- ⑭ New Sharrow Lane
- ⑮ Proposed Bike Box

Note: Final bike lane configuration and bike box locations will be subject to final determination by the Public Works Director. The Plan may be modified to accommodate required bus stops/zones and associated bus stop components in coordination with the Transportation Department.



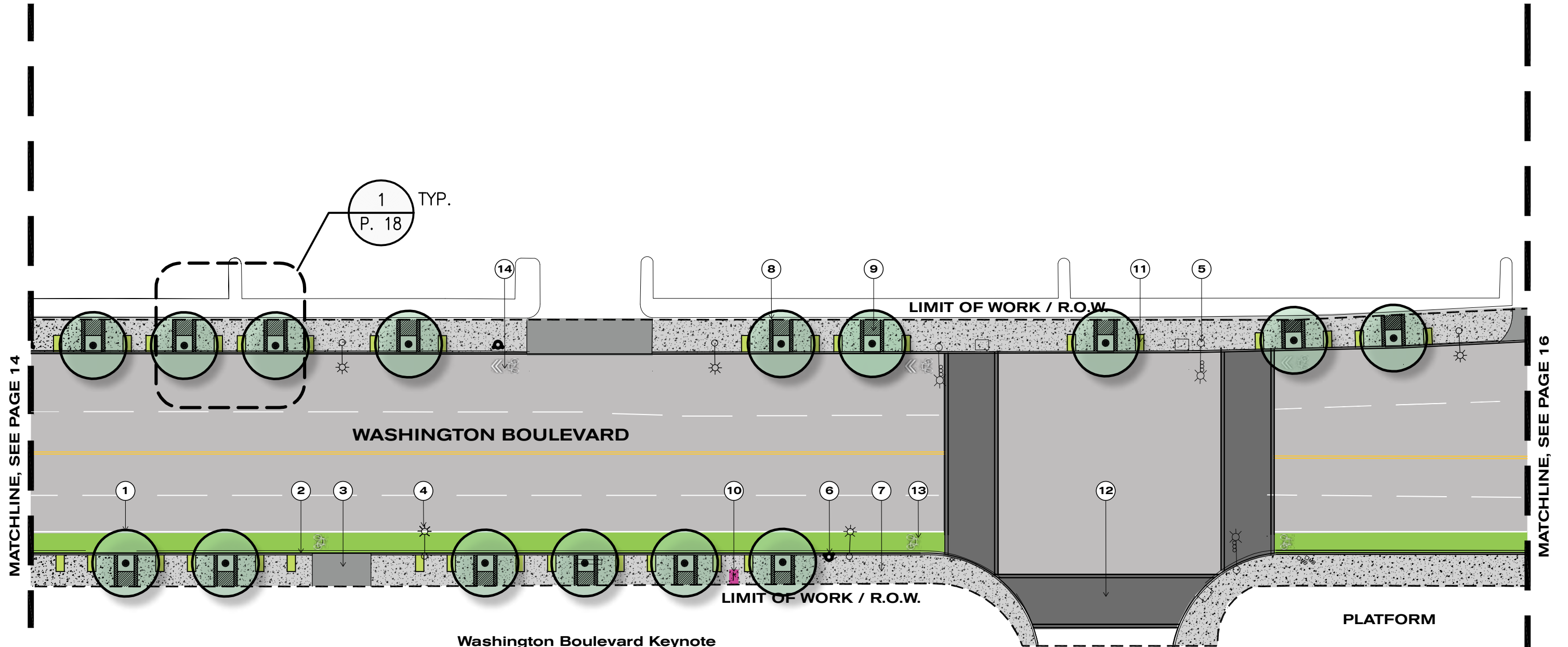

Washington Boulevard Keynote

- ① *Platanus x acerfolia* 'Bloodgood' / London Plane Tree
- ② Existing Tree To Be Removed
- ③ Existing Driveway To Remain
- ④ Existing Street Light to Remain
- ⑤ Existing Traffic Signal to Remain
- ⑥ Existing Fire Hydrant
- ⑦ New Concrete Paving
- ⑧ New Concrete Plank Pavers
- ⑨ New Permeable Pavers
- ⑩ New Pedestrian Directional Signage
- ⑪ New Planting Band
- ⑫ New Crosswalk Pavers
- ⑬ New Bike Lane
- ⑭ New Sharrow Lane
- ⑮ Proposed Bike Box

Note: Final bike lane configuration and bike box locations will be subject to final determination by the Public Works Director. The Plan may be modified to accommodate required bus stops/zones and associated bus stop components in coordination with the Transportation Department.

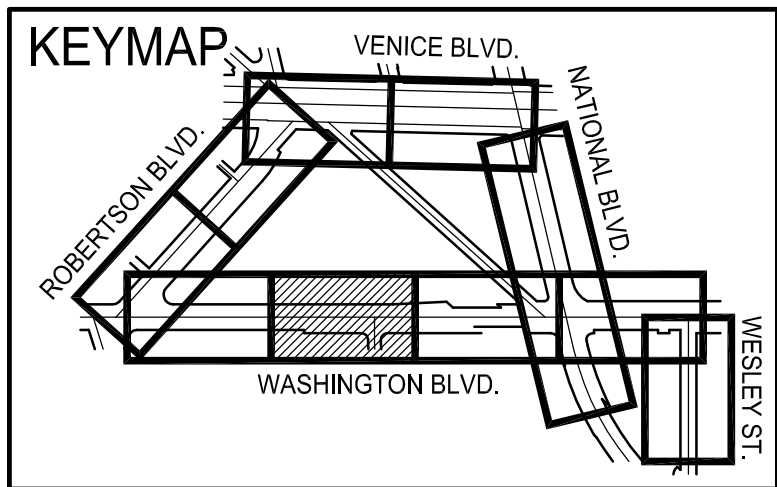

STREETScape PLAN

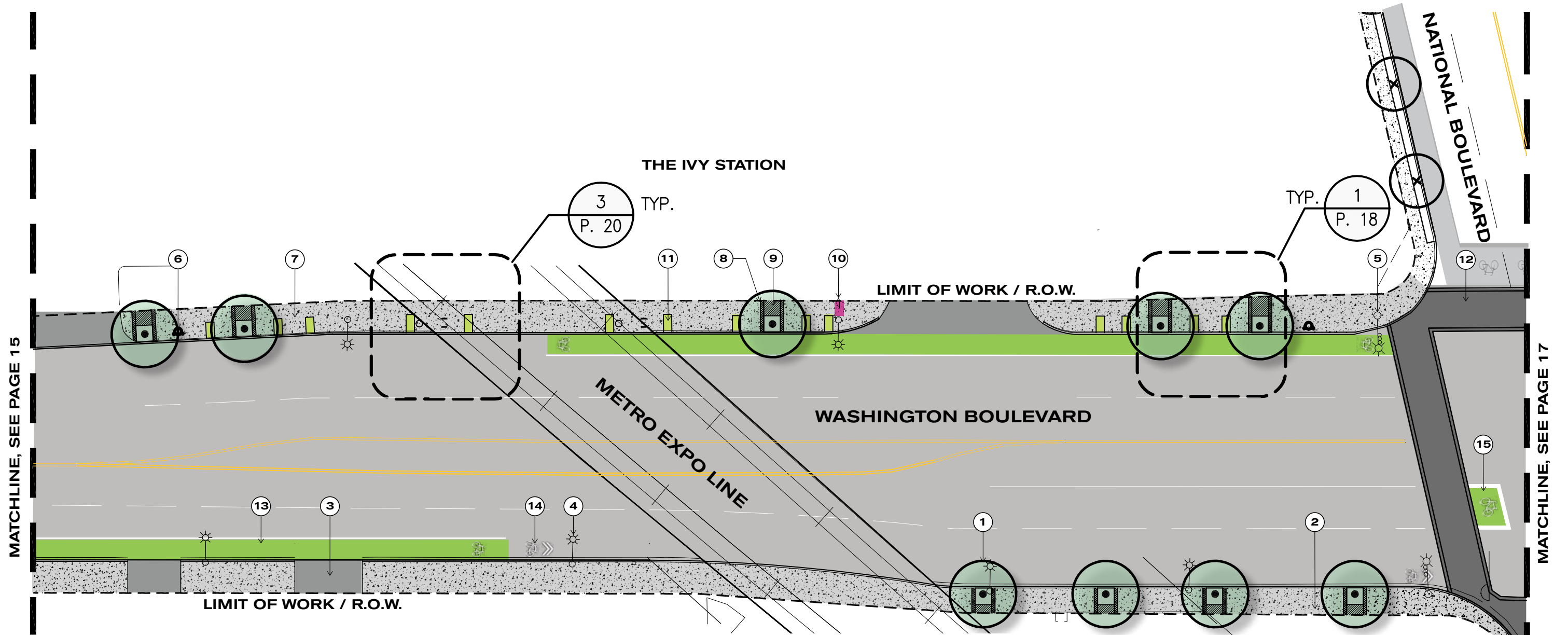

MATCHLINE, SEE PAGE 15

MATCHLINE, SEE PAGE 17

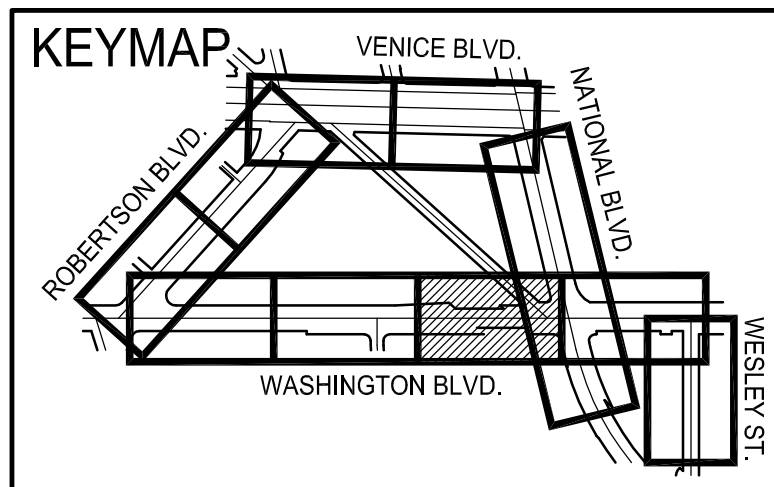

Washington Boulevard Keynote

- ① *Platanus x acerfolia* 'Bloodgood' / London Plane Tree
- ② Existing Tree To Be Removed
- ③ Existing Driveway To Remain
- ④ Existing Street Light to Remain
- ⑤ Existing Traffic Signal to Remain
- ⑥ Existing Fire Hydrant
- ⑦ New Concrete Paving
- ⑧ New Concrete Plank Pavers
- ⑨ New Permeable Pavers
- ⑩ New Pedestrian Directional Signage
- ⑪ New Planting Band
- ⑫ New Crosswalk Pavers
- ⑬ New Bike Lane
- ⑭ New Sharrow Lane
- ⑮ Proposed Bike Box

Note: Final bike lane configuration and bike box locations will be subject to final determination by the Public Works Director. The Plan may be modified to accommodate required bus stops/zones and associated bus stop components in coordination with the Transportation Department.



Note: Final bike lane configuration and bike box locations will be subject to final determination by the Public Works Director. The Plan may be modified to accommodate required bus stops/zones and associated bus stop components in coordination with the Transportation Department.

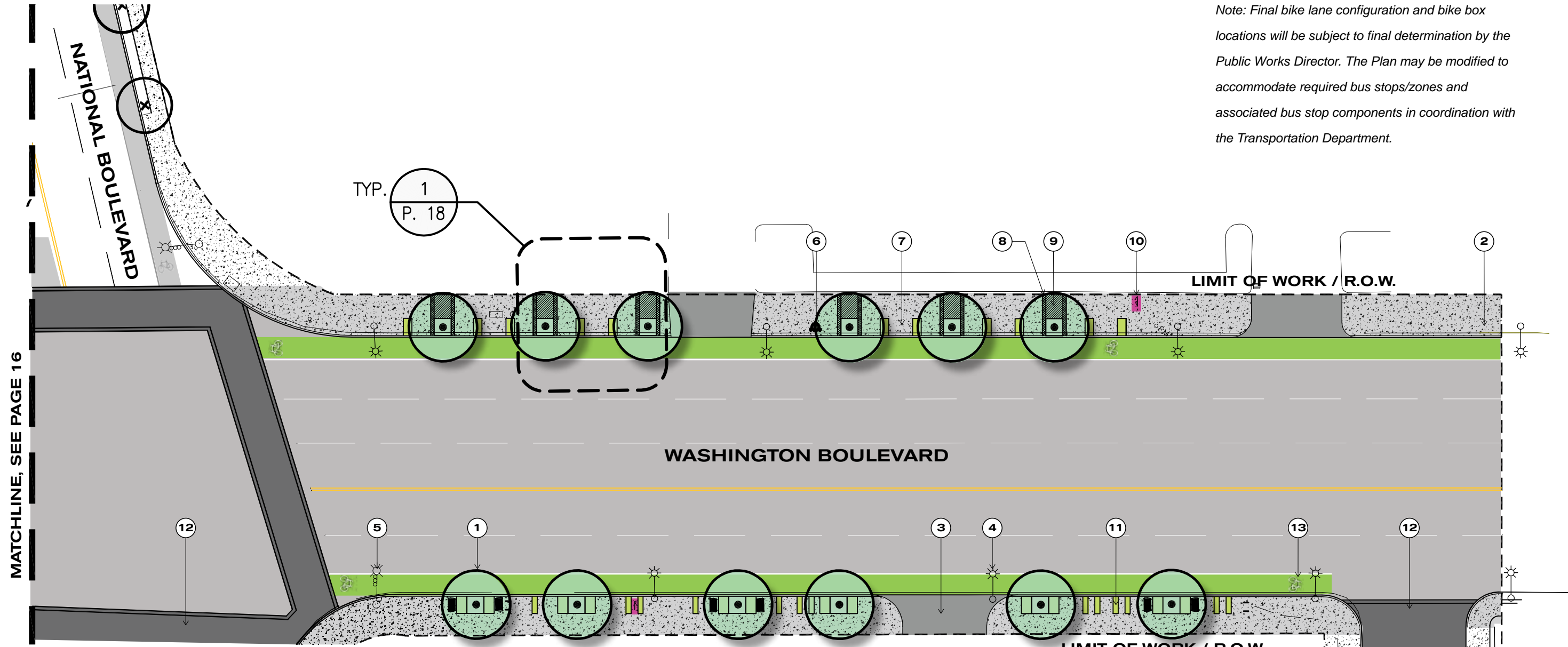

Washington Boulevard Keynote

- ① *Platanus x acerfolia* 'Bloodgood' / London Plane Tree
- ② Existing Tree To Be Removed
- ③ Existing Driveway To Remain
- ④ Existing Street Light to Remain
- ⑤ Existing Traffic Signal to Remain
- ⑥ Existing Fire Hydrant
- ⑦ New Concrete Paving
- ⑧ New Concrete Plank Pavers
- ⑨ New Permeable Pavers
- ⑩ New Pedestrian Directional Signage
- ⑪ New Planting Band
- ⑫ New Crosswalk Pavers
- ⑬ New Bike Lane
- ⑭ New Sharrow Lane
- ⑮ Proposed Bike Box

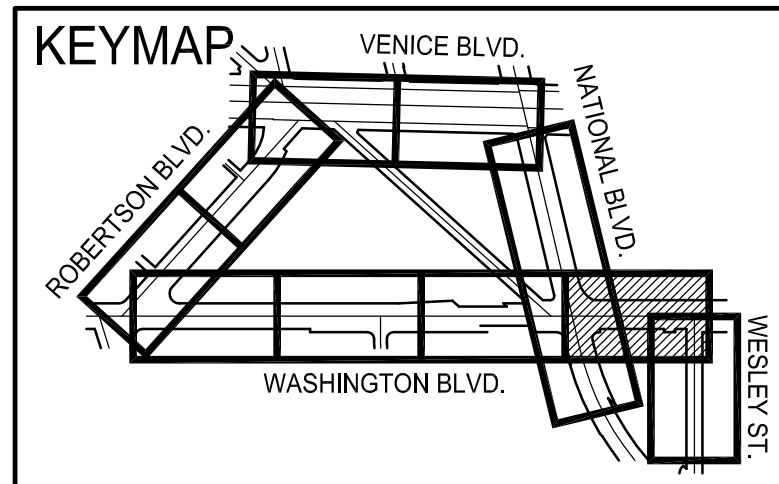

ACCESS CULVER CITY



MATCHLINE, SEE PAGE 16

DETAILS

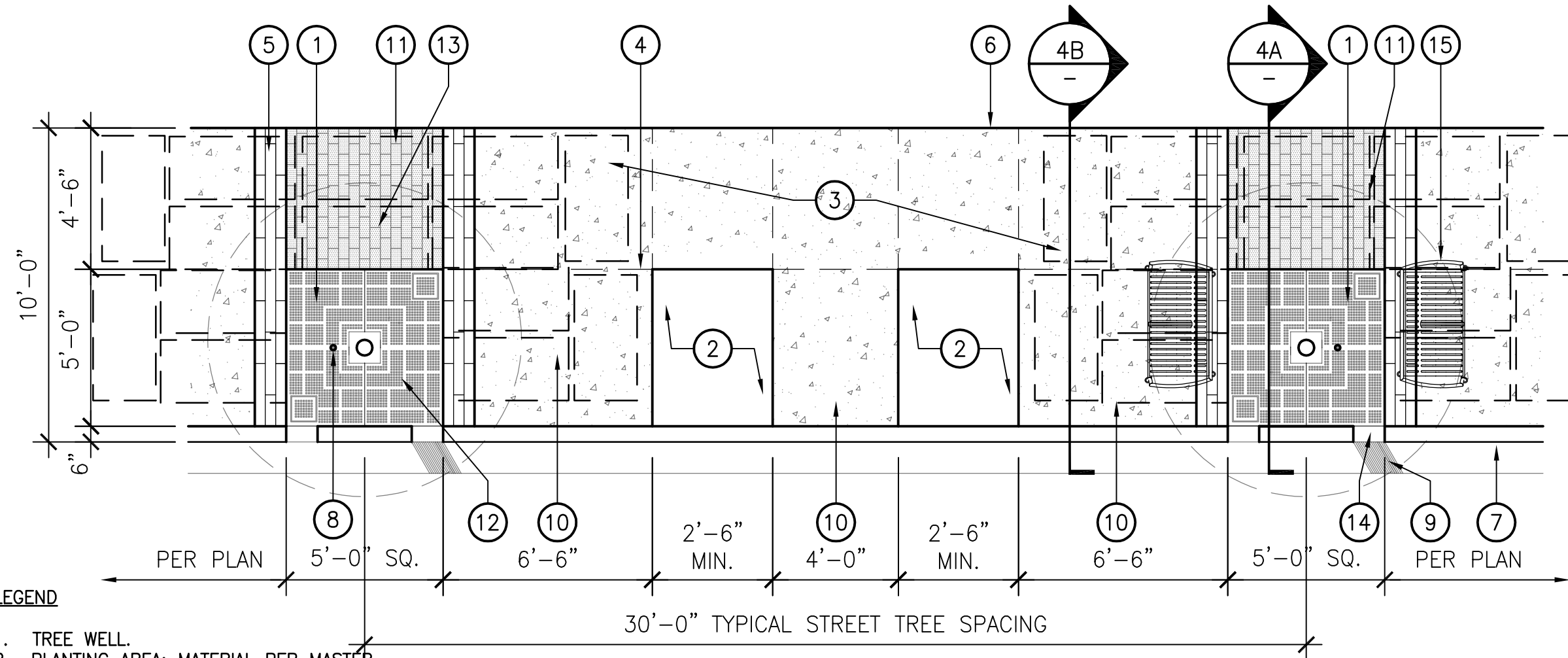

LEGEND

- 1. TREE WELL.
- 2. PLANTING AREA: MATERIAL PER MASTER PLAN.
- 3. CONCRETE: NATURAL GRAY, TOP-CAST #5.
- 4. CONCRETE JOINT TYP.
- 5. PLANK PAVERS.
- 6. RIGHT OF WAY.
- 7. FACE OF CURB.
- 8. "GRATE STAKE" BY J.R. PARTNERS.
- 9. GUTTER GROOVES ON UPHILL SIDE ONLY.
- 10. PEDESTRIAN ACCESS WHERE PARKING OCCURS.
- 11. SILVA CELLS BELOW.
- 12. TREE GRATES: 5'-0" SQUARE "MARKET STREET" BY IRONSMITH.
- 13. PERMEABLE PAVERS.

- 14. CURB IN/OUTLET; LOCATION AND QUANTITY PER PROJECT CIVIL ENGINEER.
- 15. BENCH: 49" BLACK "TOWNE SQUARE" WITH DIVIDER BY LANDSCAPE FORMS.

NOTES

- A. PROVIDE 4' O.C. SIDEWALK CONCRETE JOINTS BOTH WAYS UNLESS OTHERWISE NOTED.
- B. LOCATE BENCH COUPLET AT EVERY OTHER STREET TREE. BENCH COUPLETS TO BE NO CLOSER THAN 50' APART. FINAL LOCATION TO BE DETERMINED BY COMMUNITY DEVELOPMENT DIRECTOR.

- C. ANY DEVIATIONS FROM THIS DETAIL MUST BE FIELD INSPECTED AND APPROVED.
- D. WHERE CONFLICTS OCCURS BETWEEN DRAWINGS AND ACTUAL FIELD CONDITION, NOTIFY CITY OF CULVER CITY COMMUNITY DEVELOPMENT DEPARTMENT IN WRITING FOR CLARIFICATION. FAILURE TO PROVIDE NOTIFICATION MAY HOLD CONTRACTOR LIABLE FOR COSTS INCURRED TO RECTIFY THE PROBLEM, IF REQUIRED.

1 WASHINGTON BOULEVARD STREETSCAPE / LID TREE WELL WITH GRATE
SCALE: 1/4" = 1'-0"

114022_Washington + perm pavers.dwg

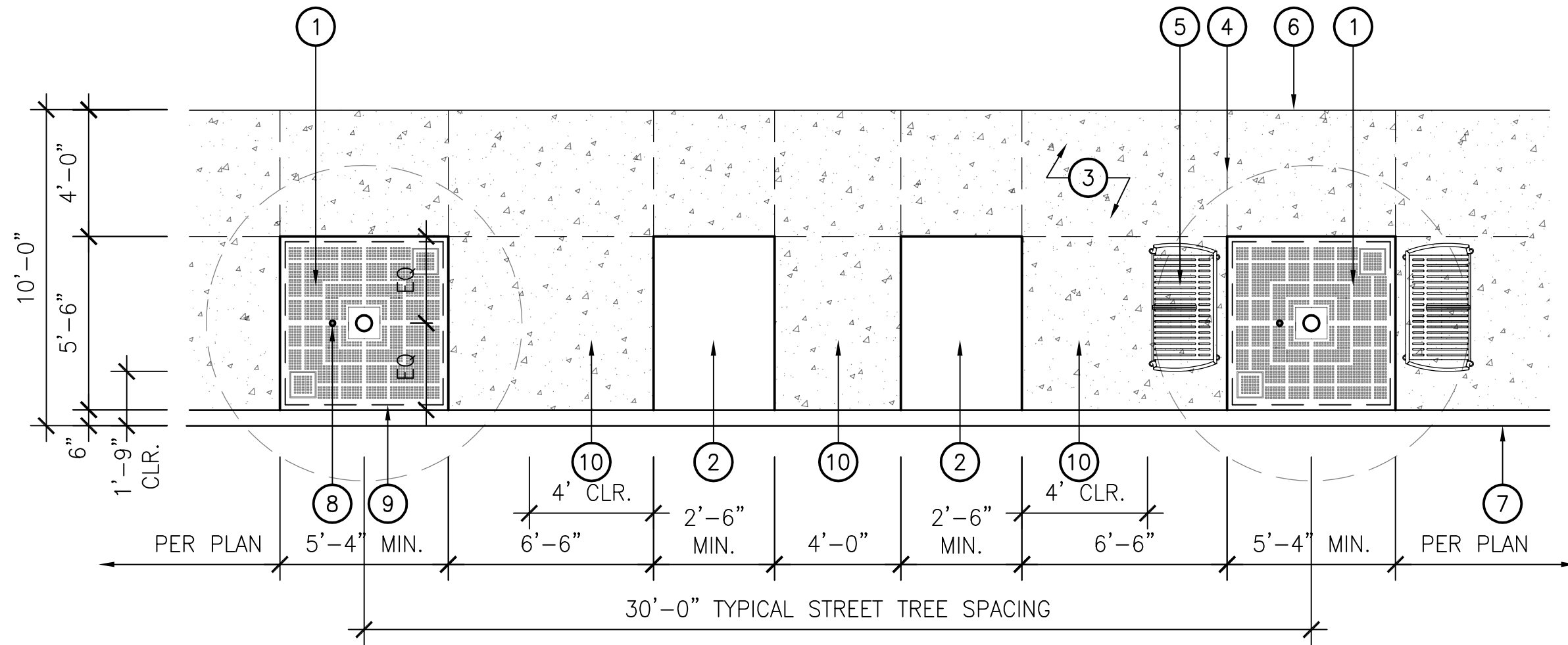

LEGEND

- 1. TREE WELL.
- 2. PLANTING AREA: MATERIAL PER MASTER PLAN.
- 3. CONCRETE: NATURAL GRAY, TOP-CAST #5.
- 4. CONCRETE JOINT TYP.
- 5. BENCH: 49" BLACK "TOWNE SQUARE" WITH DIVIDER BY LANDSCAPE FORMS.
- 6. RIGHT OF WAY.
- 7. FACE OF CURB.
- 8. "GRATE STAKE" BY J.R. PARTNERS.
- 9. ROOT BARRIER.
- 10. PEDESTRIAN ACCESS WHERE PARKING OCCURS.

NOTES

- A. ASSUME 5' O.C. SIDEWALK CONCRETE JOINTS BOTH WAYS UNLESS OTHERWISE NOTED.
- B. LOCATE BENCH COUPLET AT EVERY OTHER STREET TREE. BENCH COUPLETS TO BE NO CLOSER THAN 50' APART. FINAL LOCATION TO BE DETERMINED BY COMMUNITY DEVELOPMENT DIRECTOR.
- C. ANY DEVIATIONS FROM THIS DETAIL MUST BE FIELD INSPECTED AND APPROVED.
- D. WHERE CONFLICTS OCCURS BETWEEN DRAWINGS AND ACTUAL FIELD CONDITION, NOTIFY CITY OF CULVER CITY COMMUNITY DEVELOPMENT DEPARTMENT IN WRITING FOR CLARIFICATION. FAILURE TO PROVIDE NOTIFICATION MAY HOLD CONTRACTOR LIABLE FOR COSTS INCURRED TO RECTIFY THE PROBLEM, IF REQUIRED.

2 WASHINGTON BOULEVARD STREETSCAPE - TOD ALTERNATE TREE WELL WITH GRATE
 SCALE: 1/4" = 1'-0"

114022_Washington + Seat.dwg

DETAILS

LEGEND

1. PLANTING AREA: MATERIAL PER MASTER PLAN.
2. CONCRETE: NATURAL GRAY, TOP-CAST #5.
3. CONCRETE JOINT, TYP.
4. BIKE RACK: BLACK "SIMPLE-LOK" BY SUNSHINE U-LOK CORPORATION OR APPROVED ALTERNATIVE.
5. TRASH RECEPTACLE: 24" DIA. "SCARBOROUGH" BY LANDSCAPE FORMS.
6. RIGHT OF WAY.
7. FACE OF CURB.
8. EXTENT OF BICYCLE.

NOTES

- A. ASSUME 5' O.C. SIDEWALK CONCRETE JOINTS BOTH WAYS UNLESS NOTED OTHERWISE.
- B. ANY DEVIATIONS FROM THIS DETAIL MUST BE FIELD INSPECTED AND APPROVED.
- C. WHERE CONFLICTS OCCURS BETWEEN DRAWINGS AND ACTUAL FIELD CONDITION, NOTIFY CITY OF CULVER CITY COMMUNITY DEVELOPMENT DEPARTMENT IN WRITING FOR CLARIFICATION. FAILURE TO PROVIDE NOTIFICATION MAY HOLD CONTRACTOR LIABLE FOR COSTS INCURRED TO RECTIFY THE PROBLEM, IF REQUIRED.

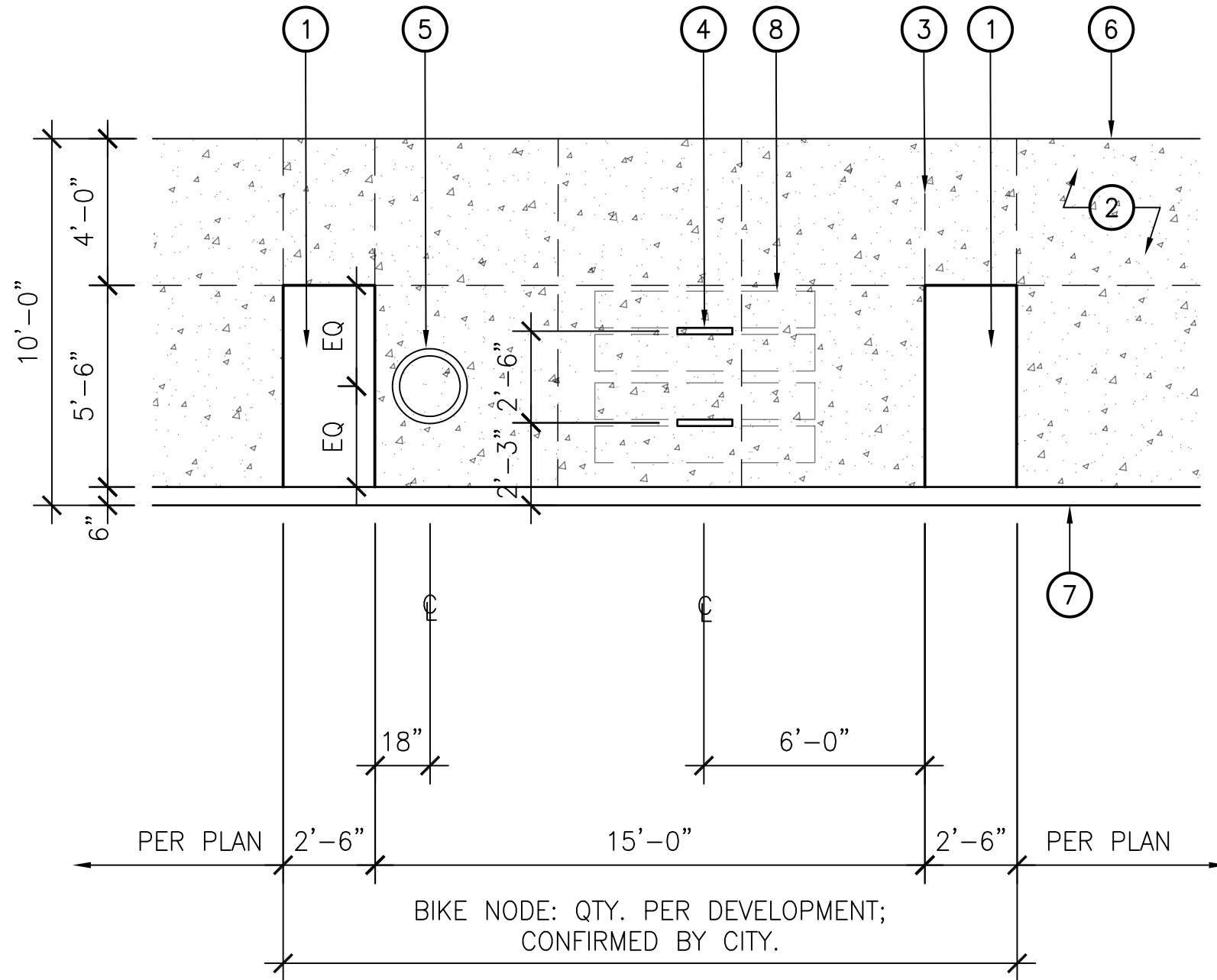

3 WASHINGTON BOULEVARD STREETSCAPE - BIKE NODE

SCALE: 1/4" = 1'-0"

114022_Washington + Bike.dwg

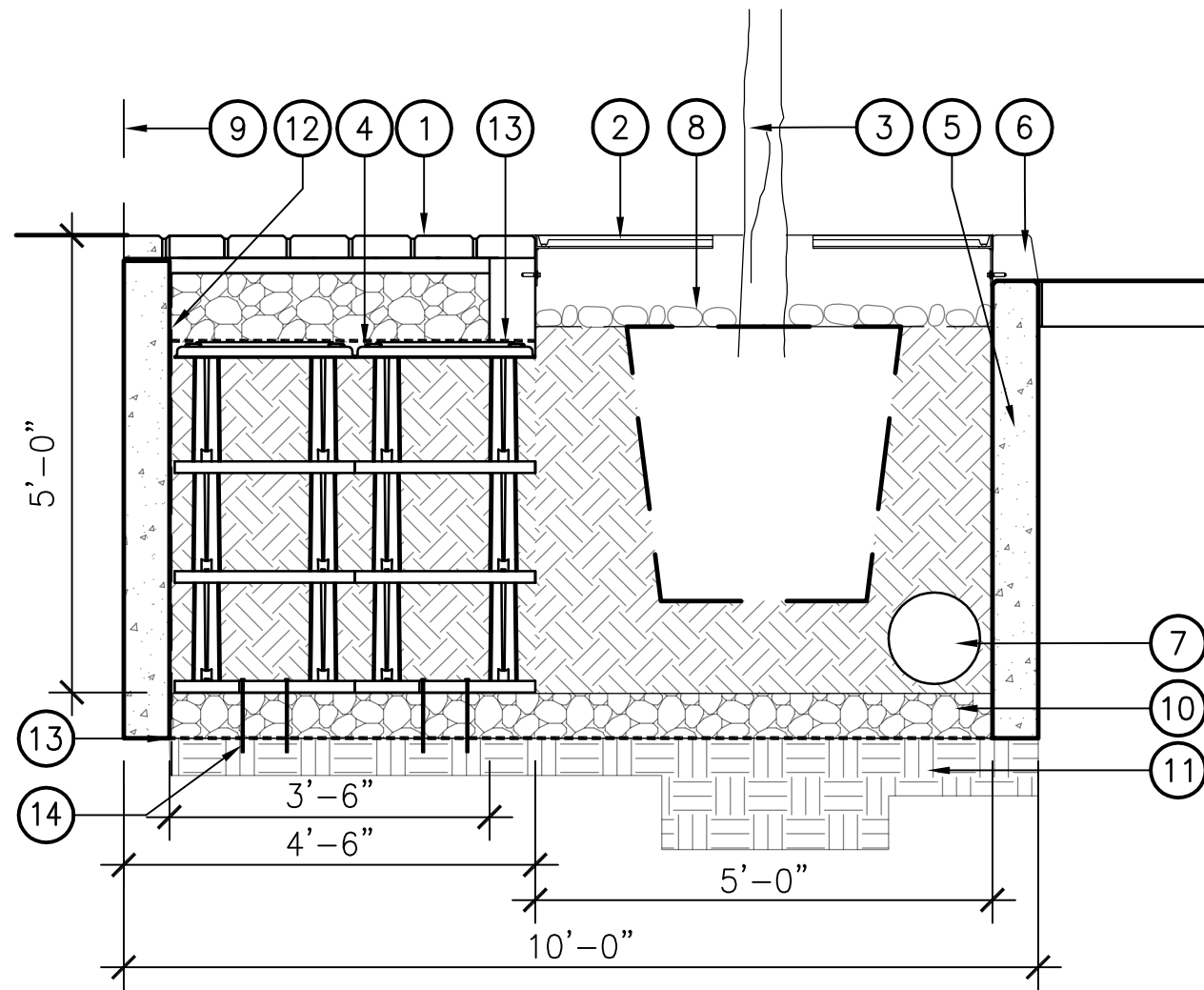

LEGEND

- | | |
|--|--|
| 1. PERMEABLE PAVERS. | 8. WASHED RIVER COBBLE. |
| 2. TREE GRATE. | 9. LIMIT OF WORK/RIGHT OF WAY. |
| 3. 36" BOX STREET TREE. | 10. COMPACTED CRUSHED ROCK. |
| 4. "SILVA CELLS" BY DEEP ROOT. | 11. SUBGRADE COMPACTED PER GEOTECHNICAL REPORT. |
| 5. FILTRATION PLANTER. | 12. MOISTURE BARRIER, DEPTH PER PROJECT GEOTECHNICAL ENGINEER RECOMMENDATIONS. |
| 6. ROADWAY CURB. | 13. GEOTEXTILE FABRIC |
| 7. 12" ϕ DETENTION PIPE, CONNECT TO STORM DRAIN, CONFIRM W/ PROJECT CIVIL ENGINEER. | 14. 10" SPIKES |

4A WASHINGTON + FILTRATION PLANTER
 SCALE: 1/2" = 1'-0" 114022_Washington+Filtration Planter section.dwg

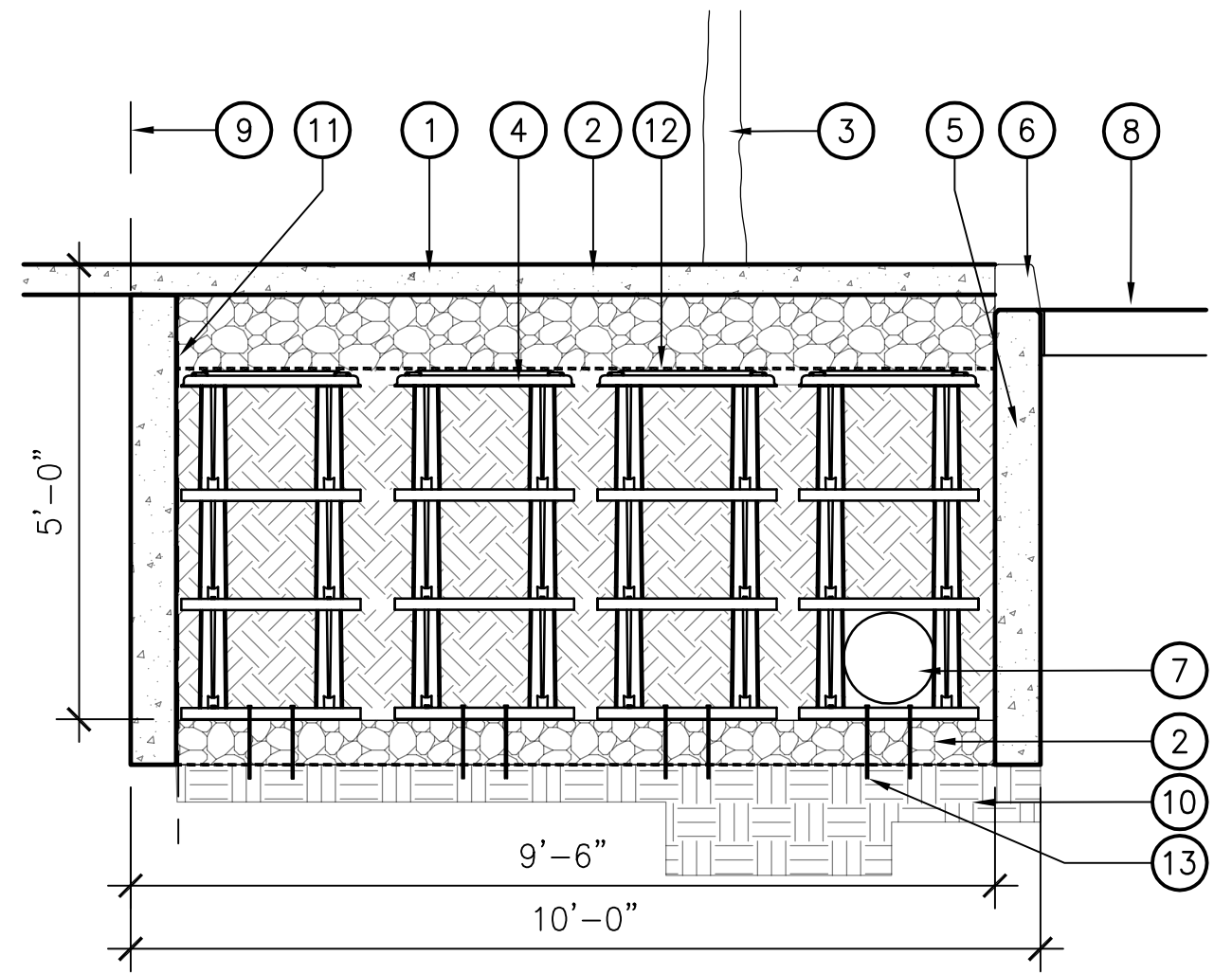

LEGEND

- | | |
|---|--|
| 1. CONCRETE: NATURAL GRAY, TOP-CAST #5. | 8. ROADWAY. |
| 2. COMPACTED CRUSHED ROCK. | 9. LIMIT OF WORK/RIGHT OF WAY. |
| 3. STREE TREE (BEYOND). | 10. SUBGRADE COMPACTED PER GEOTECHNICAL REPORT. |
| 4. "SILVA CELLS" BY DEEP ROOT. | 11. MOISTURE BARRIER, DEPTH PER PROJECT GEOTECHNICAL ENGINEER RECOMMENDATIONS. |
| 5. FILTRATION PLANTER. | 12. GEOTEXTILE FABRIC |
| 6. ROADWAY CURB. | 13. 10" SPIKES |
| 7. 12" DETENTION PIPE, CONNECT TO STORM DRAIN, CONFIRM WITH PROJECT CIVIL ENGINEER. | |

4B WASHINGTON + FILTRATION PLANTER
 SCALE: 1/2" = 1'-0" 114022_Washington+Filtration Planter section.dwg

VENICE BOULEVARD



Carex alma / Sturdy Sedge



Muhlenbergia rigens / Deer Grass



Lagerstroemia fauriei 'Natchez' / 'Natchez' Crape Myrtle

Venice Boulevard is the front door to the district on its northern edge. This length is characterized by commercial businesses, driveways, overhead utilities, and a generous 24 to 35 foot wide right-of-way lacking any significant vegetation.

A wide planted bioswale is proposed to capture stormwater and buffer pedestrians from the busy boulevard. *Lagerstroemia fauriei* 'Natchez' street trees placed at a maximum 30 feet on center will be planted in the bioswale and will be under-planted with *Muhlenbergia rigens* and *Carex alma*, or other similar ground cover as approved by the City. This section will be known as the *Venice Boulevard Biofiltration Channel*. This comfortable, pedestrian-focused, sustainable streetscape treatment will be viewed by transit users as they descend from the Expo station platform.



VIEW LOOKING WEST ON VENICE BOULEVARD

STREETScape PLAN

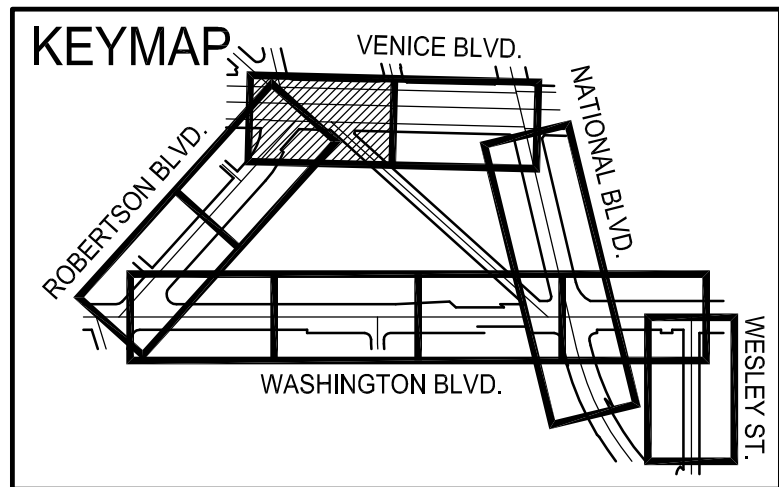

Venice Boulevard Keynote

- ① *Lagerstroemia fauriei* 'Natchez' / 'Natchez' Crape Myrtle
- ② Existing Tree To Be Removed
- ③ Existing Street Light to Remain
- ④ Existing Traffic Signal to Remain
- ⑤ Existing Fire Hydrant
- ⑥ New Concrete Paving
- ⑦ New Directory Signage
- ⑧ New Pedestrian Directional Signage
- ⑨ New Filtration Planter
- ⑩ New Crosswalk Pavers (crosswalk subject to City of Los Angeles / Caltrans approval)
- ⑪ New Bus Shelters

VENICE BOULEVARD

LIMIT OF WORK / R.O.W.

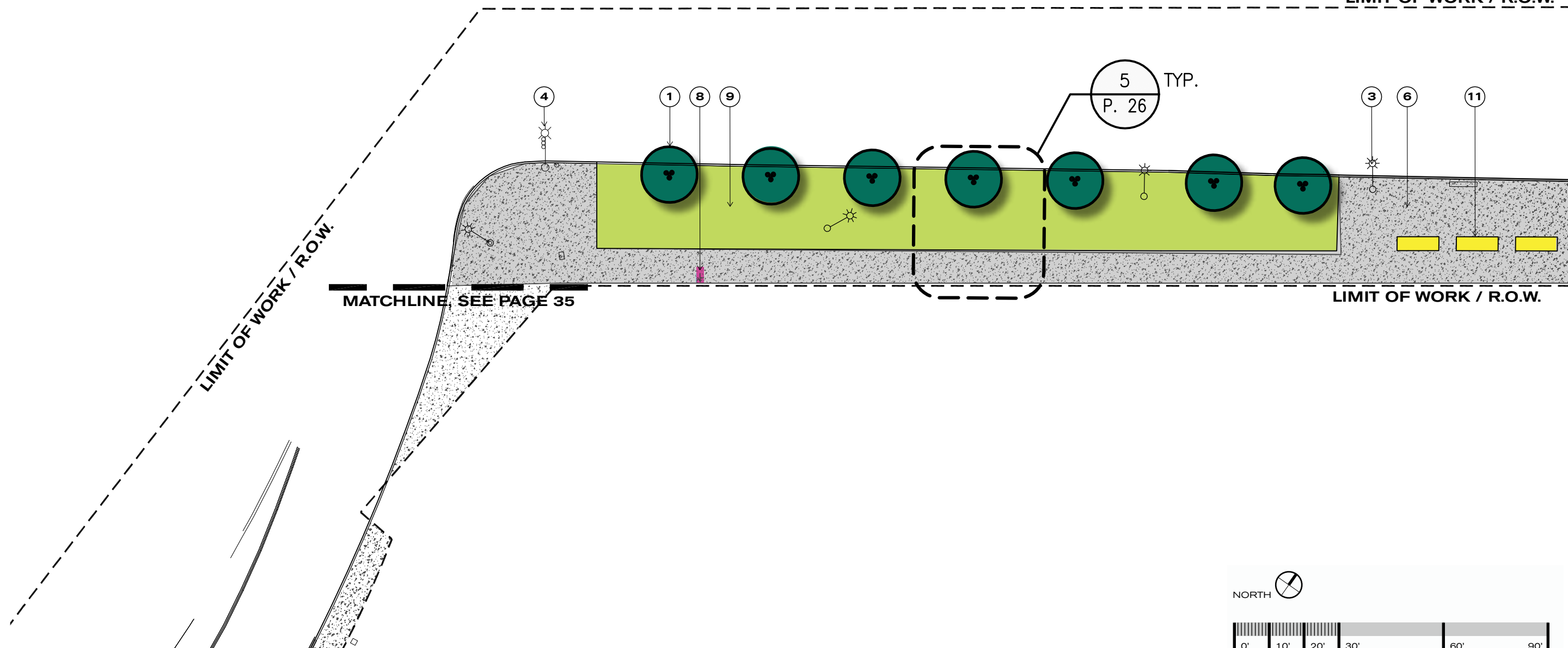

MATCHLINE, SEE PAGE 35

LIMIT OF WORK / R.O.W.

LIMIT OF WORK / R.O.W.

MATCHLINE, SEE PAGE 25



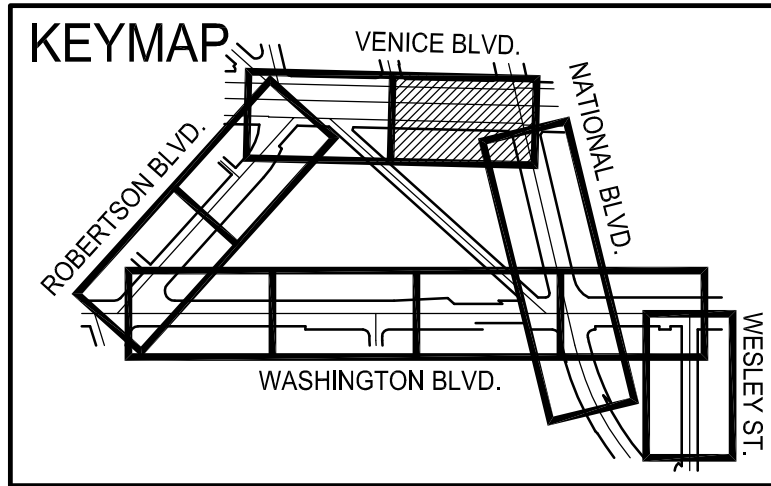

Venice Boulevard Keynote

- ① *Lagerstroemia fauriei* 'Natchez' / 'Natchez' Crape Myrtle
- ② Existing Tree To Be Removed
- ③ Existing Street Light to Remain
- ④ Existing Traffic Signal to Remain
- ⑤ Existing Fire Hydrant
- ⑥ New Concrete Paving
- ⑦ New Directory Signage
- ⑧ New Pedestrian Directional Signage
- ⑨ New Filtration Planter
- ⑩ New Crosswalk Pavers (crosswalk subject to City of Los Angeles / Caltrans approval)
- ⑪ New Bus Shelters

LIMIT OF WORK / R.O.W.

MATCHLINE, SEE PAGE 24

VENICE BOULEVARD

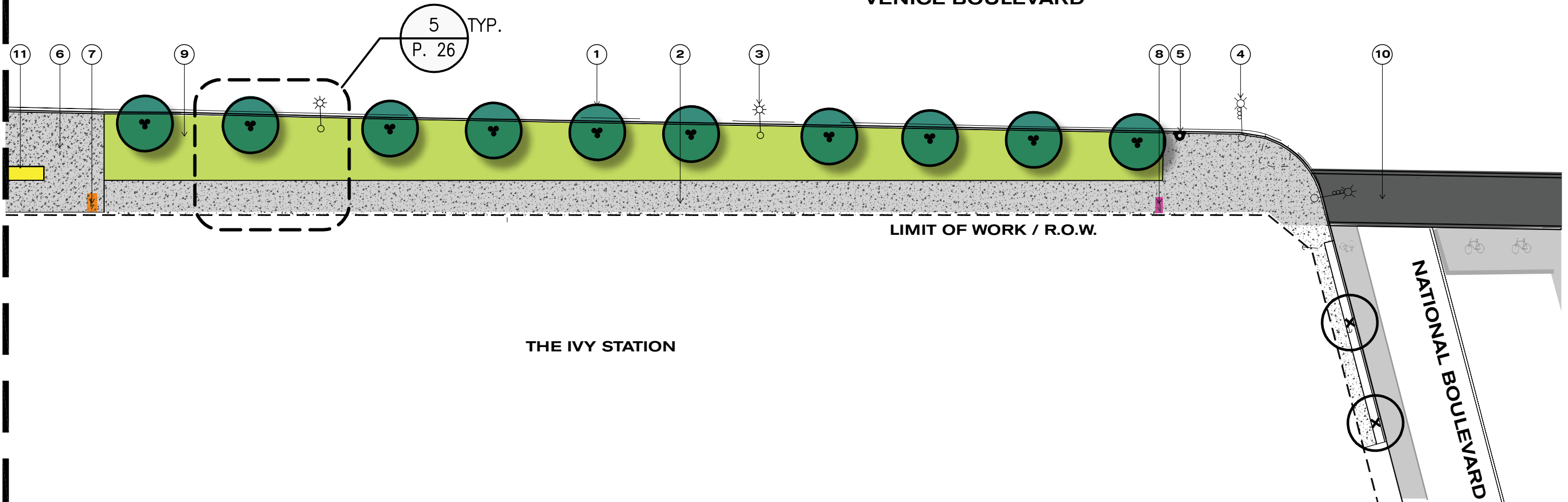

THE IVY STATION

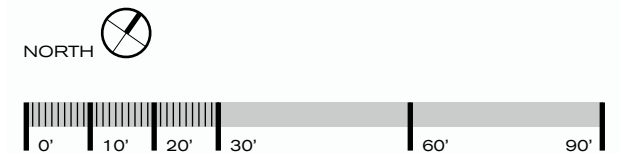

DETAILS

LEGEND

1. FILTRATION PLANTER.
2. PLANTING AREA: MATERIAL PER MASTER PLAN.
3. CONCRETE: NATURAL GRAY, TOP-CAST #5.
4. CONCRETE JOINT TYP.
5. RIGHT OF WAY/FACE OF BUILDING.
6. FACE OF CURB.
7. TREE STAKING.
8. CURB IN/OUTLETS; FREQUENCY AND LOCATION PER PROJECT CIVIL ENGINEER.
9. FILTRATION PLANTER EDGE.
10. GUTTER GROOVES ON UPHILL SIDE ONLY.

NOTES

- A. PROVIDE 5' O.C. SIDEWALK CONCRETE JOINTS BOTH WAYS UNLESS OTHERWISE NOTED.

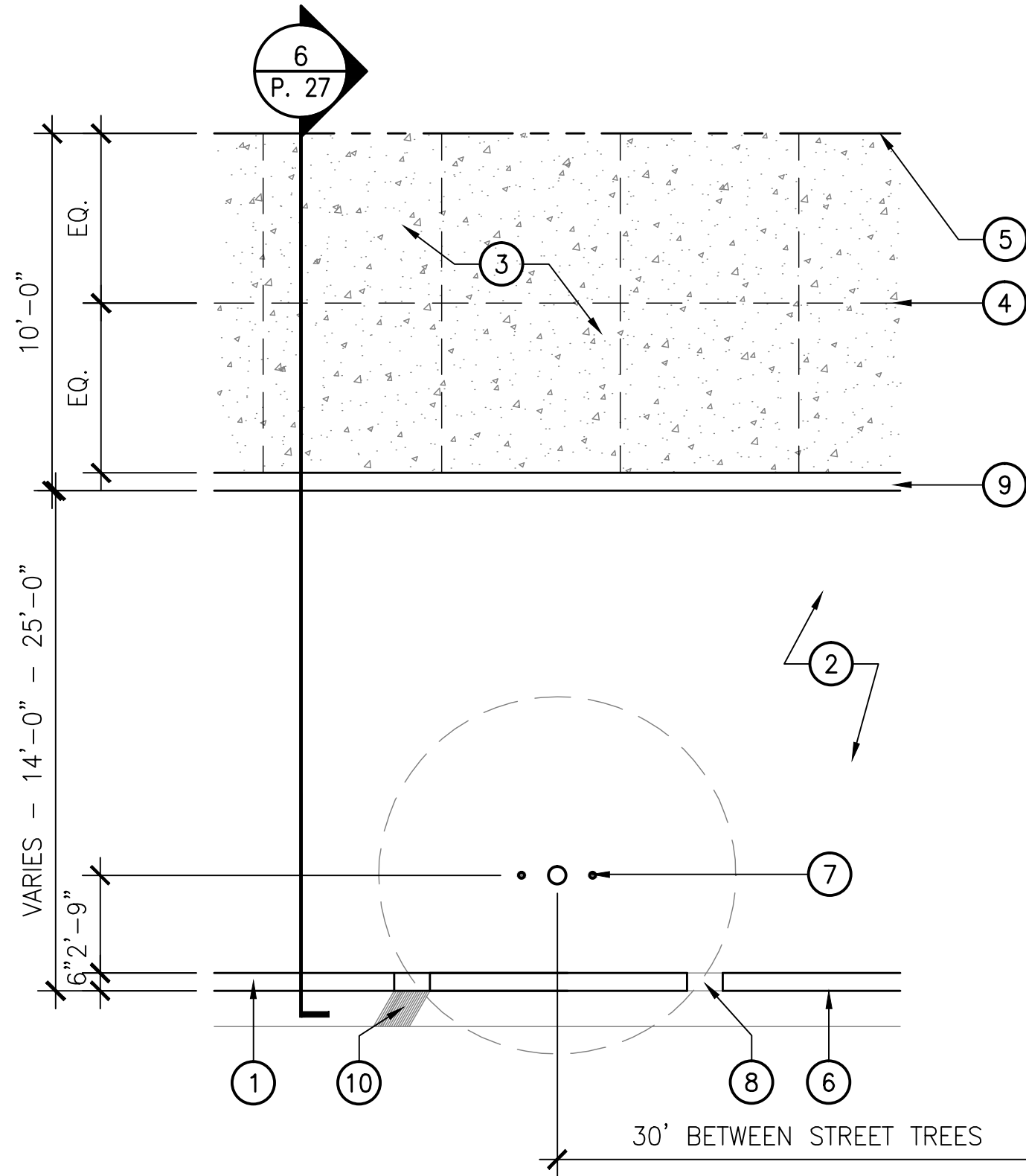

5 VENICE + FILTRATION PLANTER
SCALE: 1/4" = 1'-0"

114022_venice bioswale + filtration planter plan.dwg

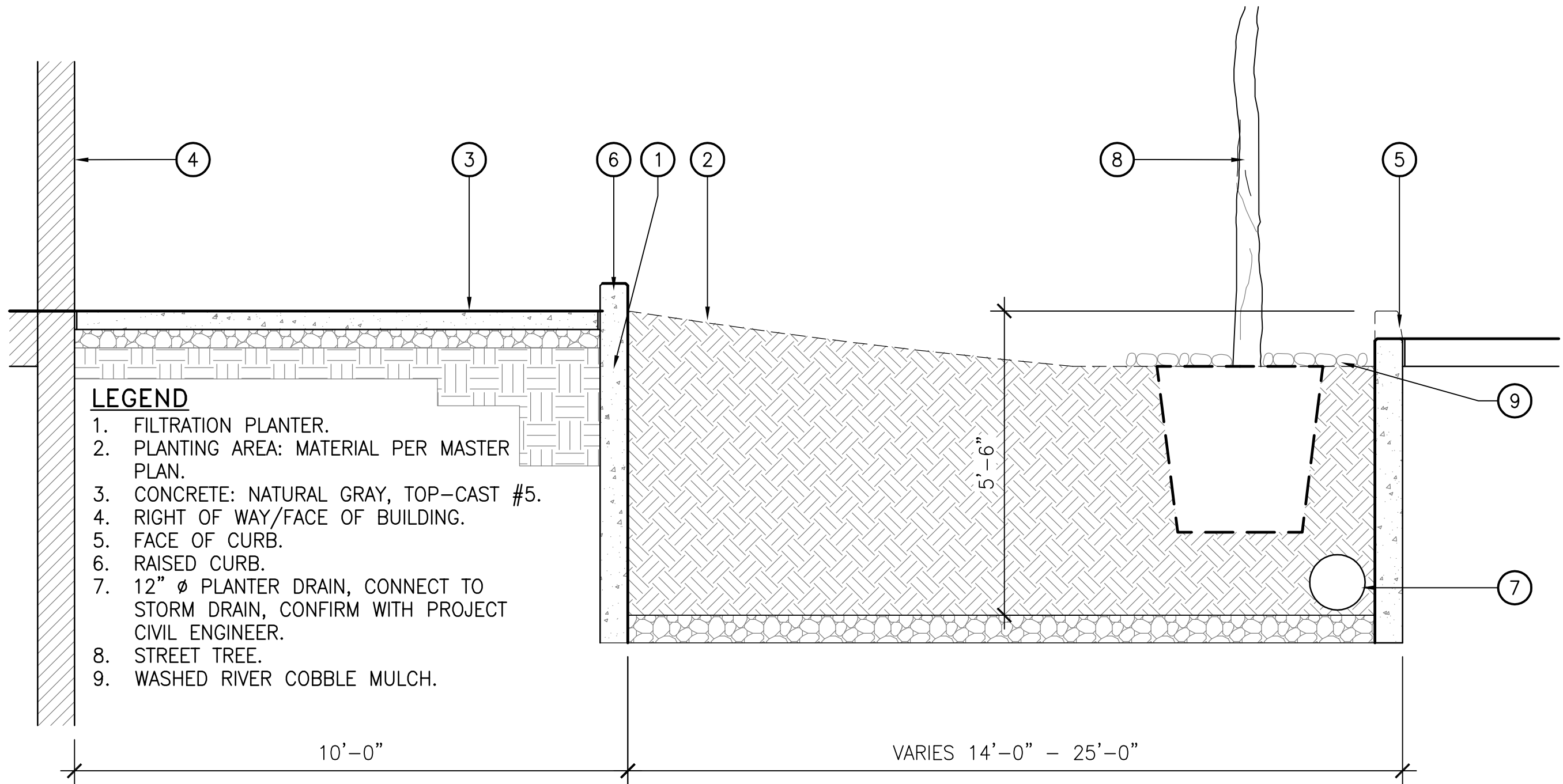

6 VENICE BIOSWALE + FILTRATION PLANTER
 SCALE: 1/2" = 1'-0"

114022_Venice Bioswale + Filtration Planter_Section.dwg

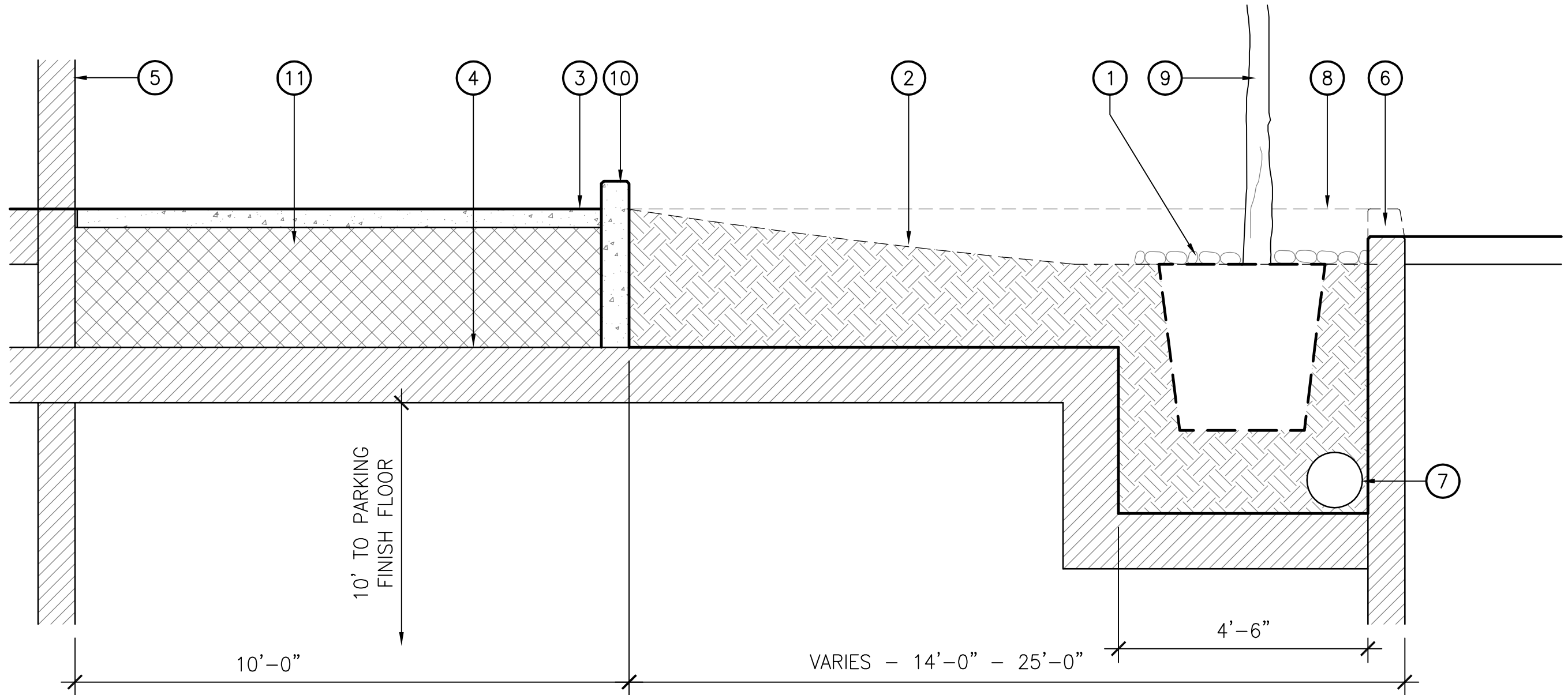

LEGEND

- | | | |
|---|--|--|
| <ul style="list-style-type: none"> 1. WASHED RIVER COBBLE MULCH. 2. PLANTING AREA: MATERIAL PER MASTER PLAN. 3. CONCRETE: NATURAL GRAY, TOP-CAST #5. 4. PARKING GARAGE BELOW. | <ul style="list-style-type: none"> 5. RIGHT OF WAY/FACE OF BUILDING. 6. CURB. 7. 12" ϕ DETENTION PIPE, CONNECT TO STORM DRAIN, CONFIRM WITH PROJECT CIVIL ENGINEER. | <ul style="list-style-type: none"> 8. PAVING FOR PEDESTRIAN ACCESS WHERE DRIVEWAY OR BUS STOP OCCURS. 9. STREET TREE. 10. RAISED CURB. 11. BASE MATERIAL PER PROJECT ARCHITECT |
|---|--|--|

7 VENICE BIOSWALE + PARKING GARAGE ALTERNATIVE
 SCALE: 1/2" = 1'-0"

114022_Venice Bioswale + Parking Garage_Section.dwg

THIS PAGE INTENTIONALLY LEFT BLANK

NATIONAL & ROBERTSON BOULEVARDS

NATIONAL BOULEVARD



Lagerstroemia fauriei 'Natchez' / 'Natchez' Crape Myrtle



Carex alma / Sturdy Sedge

ROBERTSON BOULEVARD



Ginkgo biloba / Ginkgo



Festuca glauca / Blue Fescue

National and Robertson Boulevards are planned as walkable *green streets* connecting Venice and Washington Boulevards in the *Washington National Transit Oriented Development District*. Both of these streets have 8 foot wide right-of-ways.

These connector streets will have upright canopy street trees such as *Ginkgo biloba* or *Lagerstroemia indica x fauriei* 'Natchez' placed at a maximum of 30 feet on center. On both National and Robertson, a planted parkway of *Carex alma*, *Festuca glauca*, and *Muhlenbergia capillaris* will buffer pedestrians from vehicular traffic and capture stormwater in a concrete filtration planter.



VIEW LOOKING EAST ON NATIONAL BOULEVARD

STREETScape PLAN

Note: Final bike lane configuration and bike box locations will be subject to final determination by the Public Works Director. The Plan may be modified to accommodate required bus stops/zones and associated bus stop components in coordination with the Transportation Department.

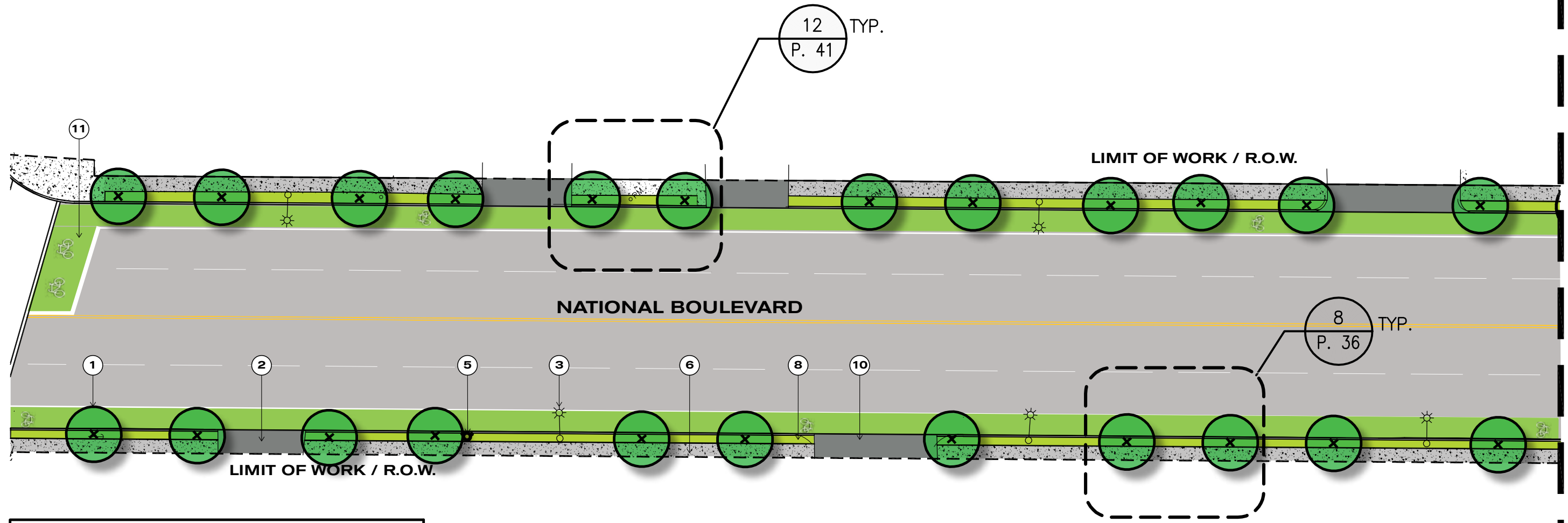

MATCHLINE, SEE PAGE 33

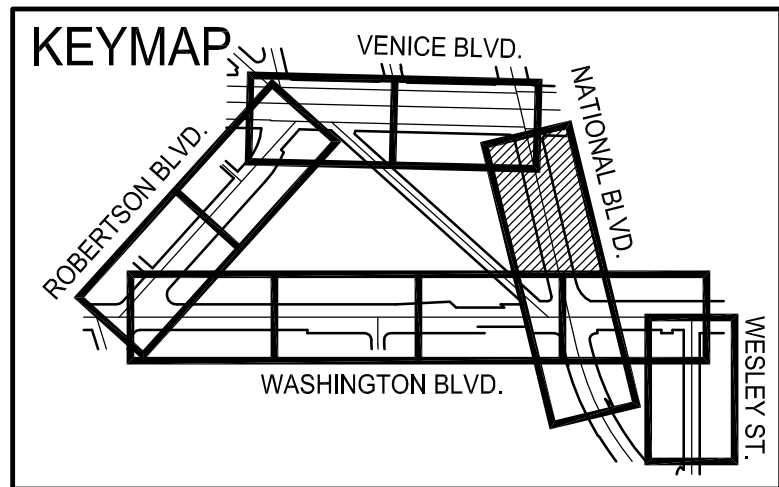

National Boulevard Keynote

- ① Lagerstroemia fauriei 'Natchez' / 'Natchez' Crape Myrtle
- ② Existing Driveway To Remain
- ③ Existing Street Light to Remain
- ④ Existing Traffic Signal to Remain
- ⑤ Existing Fire Hydrant
- ⑥ New Concrete Paving
- ⑦ New Planting Band
- ⑧ New Planting Area
- ⑨ New Crosswalk Pavers
- ⑩ New Bike Lane
- ⑪ Proposed Bike Box

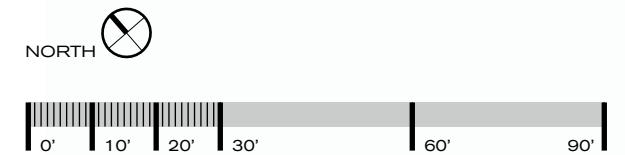

Note: Final bike lane configuration and bike box locations will be subject to final determination by the Public Works Director. The Plan may be modified to accommodate required bus stops/zones and associated bus stop components in coordination with the Transportation Department.

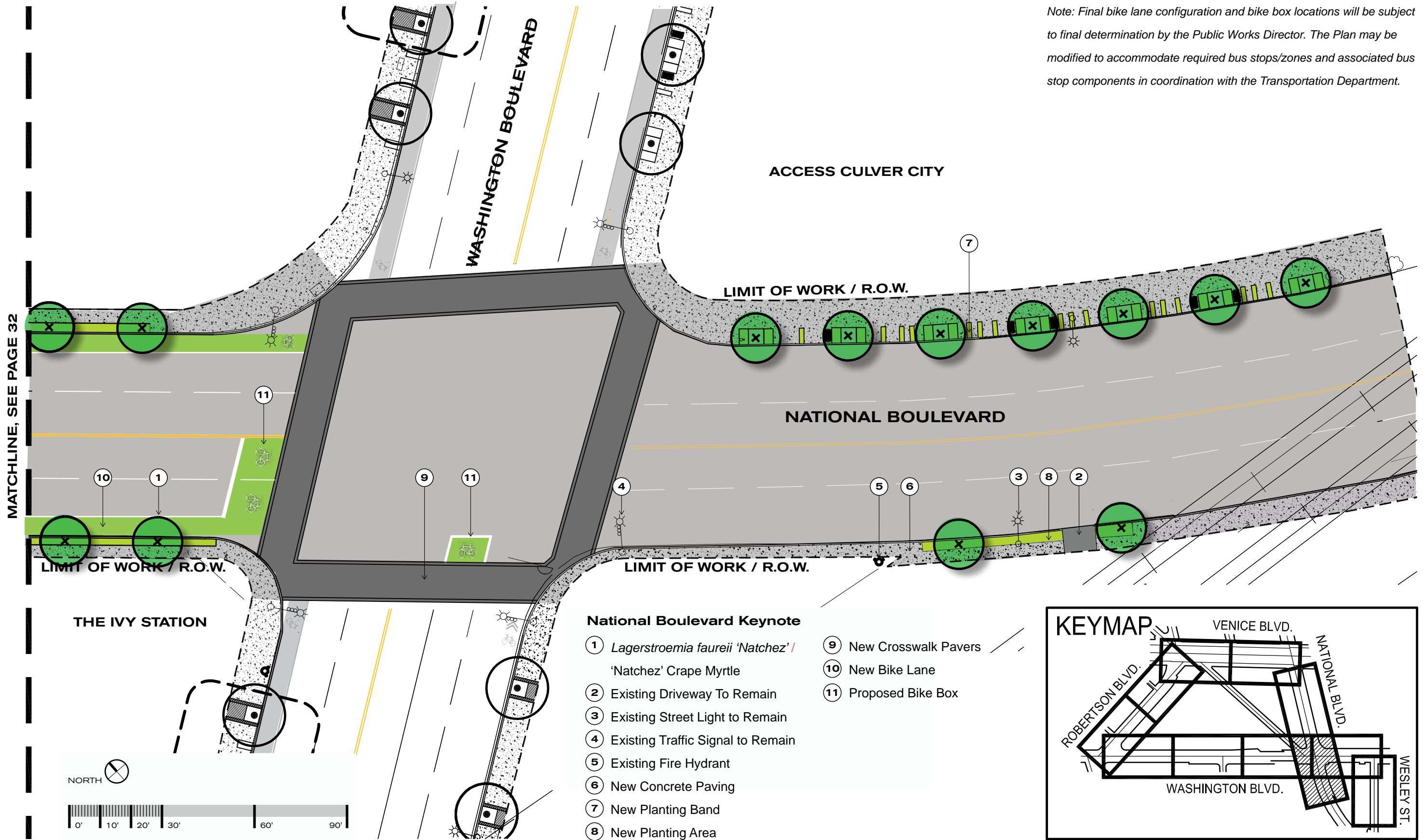

MATCHLINE, SEE PAGE 32

THE IVY STATION



National Boulevard Keynote

- ① *Lagerstroemia faureii* 'Natchez' / 'Natchez' Crape Myrtle
- ② Existing Driveway To Remain
- ③ Existing Street Light to Remain
- ④ Existing Traffic Signal to Remain
- ⑤ Existing Fire Hydrant
- ⑥ New Concrete Paving
- ⑦ New Planting Band
- ⑧ New Planting Area
- ⑨ New Crosswalk Pavers
- ⑩ New Bike Lane
- ⑪ Proposed Bike Box

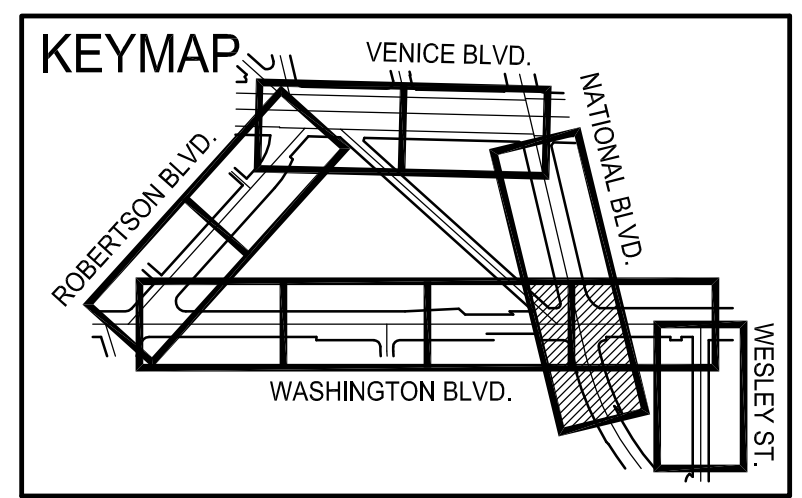

STREETScape PLAN

Robertson Boulevard Keynote

- ① *Ginkgo biloba* / Ginkgo
- ② Existing Tree To Be Removed
- ③ Existing Driveway To Remain
- ④ Existing Street Light to Remain
- ⑤ New Concrete Paving
- ⑥ New Directory Signage
- ⑦ New Planting Band
- ⑧ New Planting Area
- ⑨ New Bus Shelters

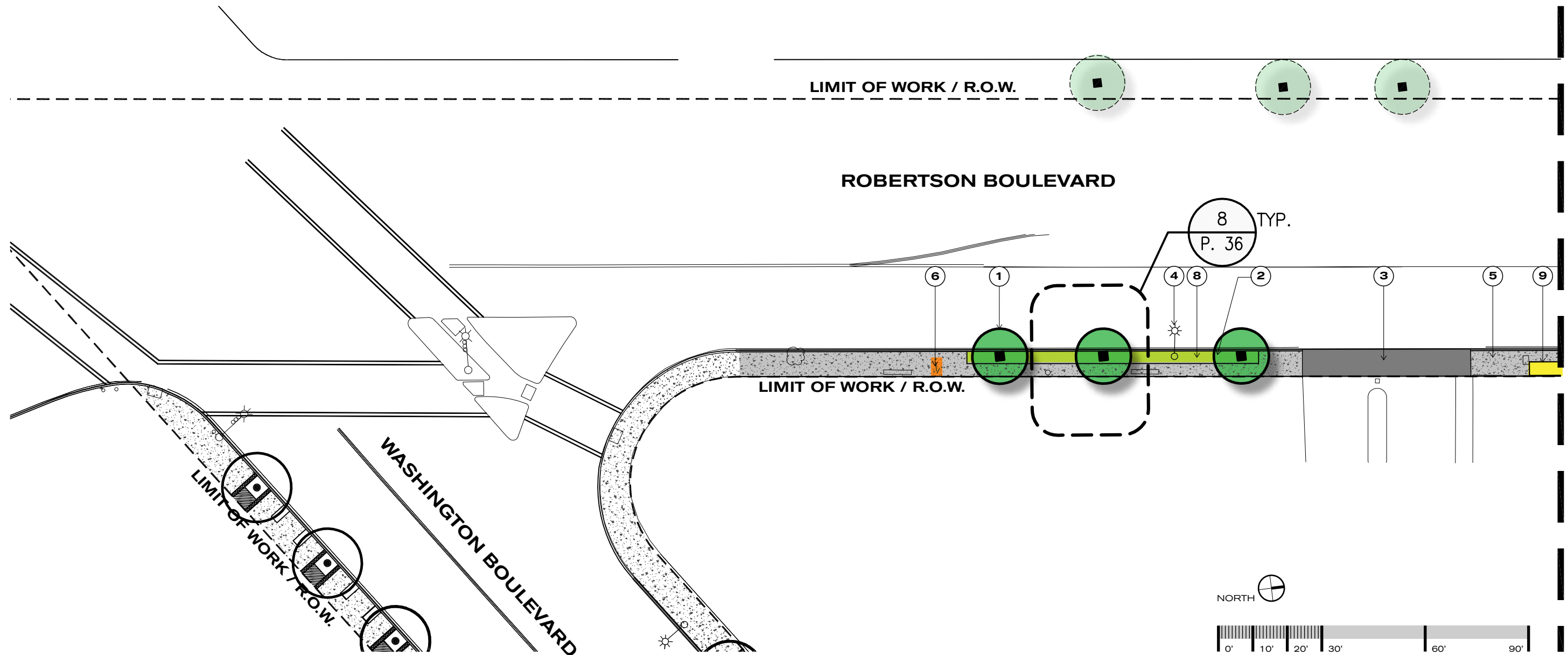
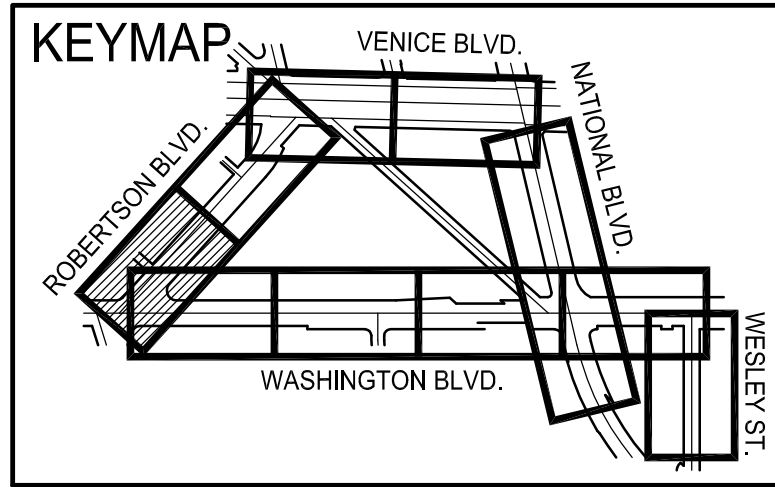

MATCHLINE, SEE PAGE 35

Robertson Boulevard Keynote

- ① *Ginkgo biloba* / Ginkgo
- ② Existing Tree To Be Removed
- ③ Existing Driveway To Remain
- ④ Existing Street Light to Remain
- ⑤ New Concrete Paving
- ⑥ New Directory Signage
- ⑦ New Planting Band
- ⑧ New Planting Area
- ⑨ New Bus Shelters

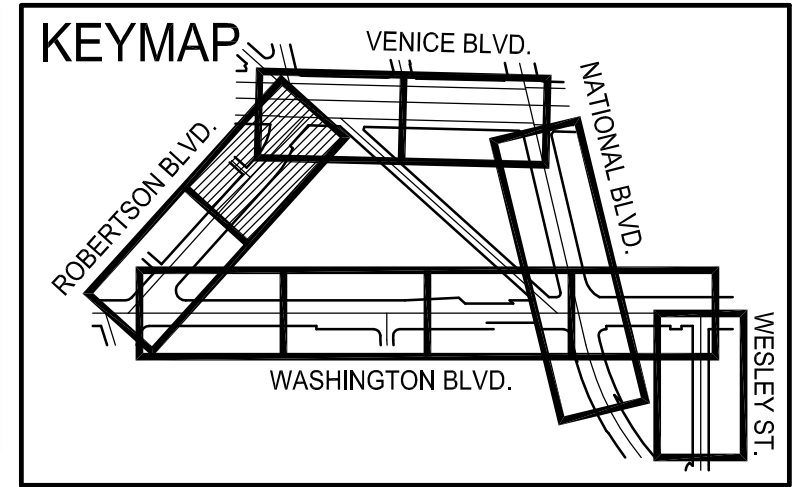

MATCHLINE, SEE PAGE 34

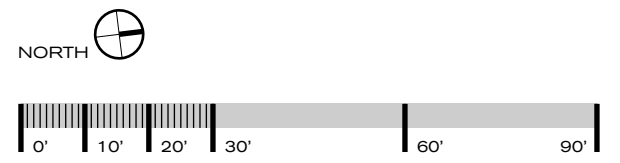
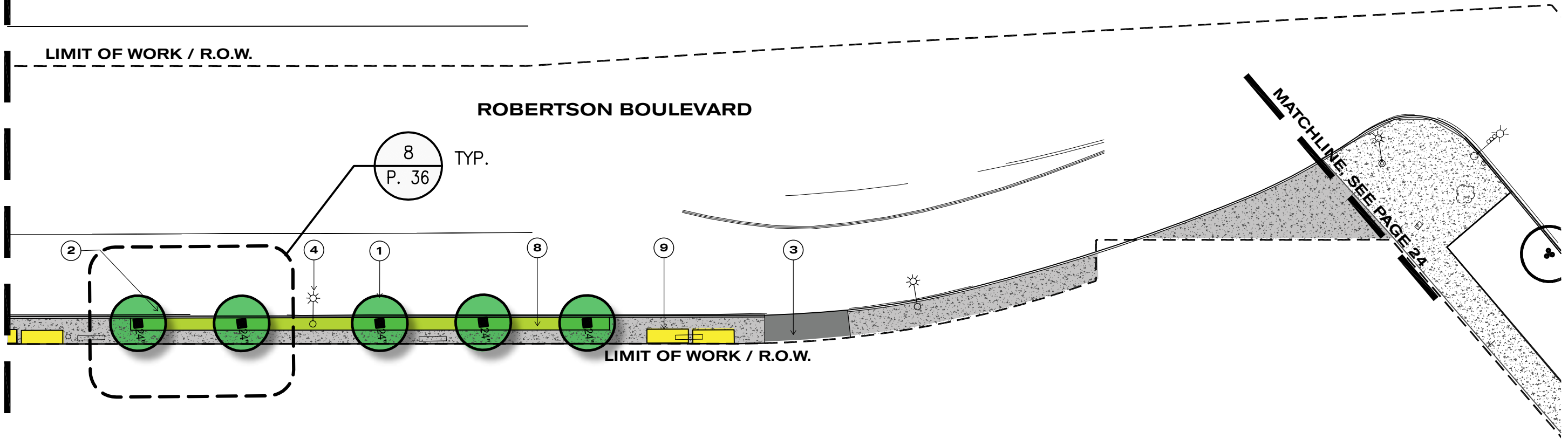

DETAILS

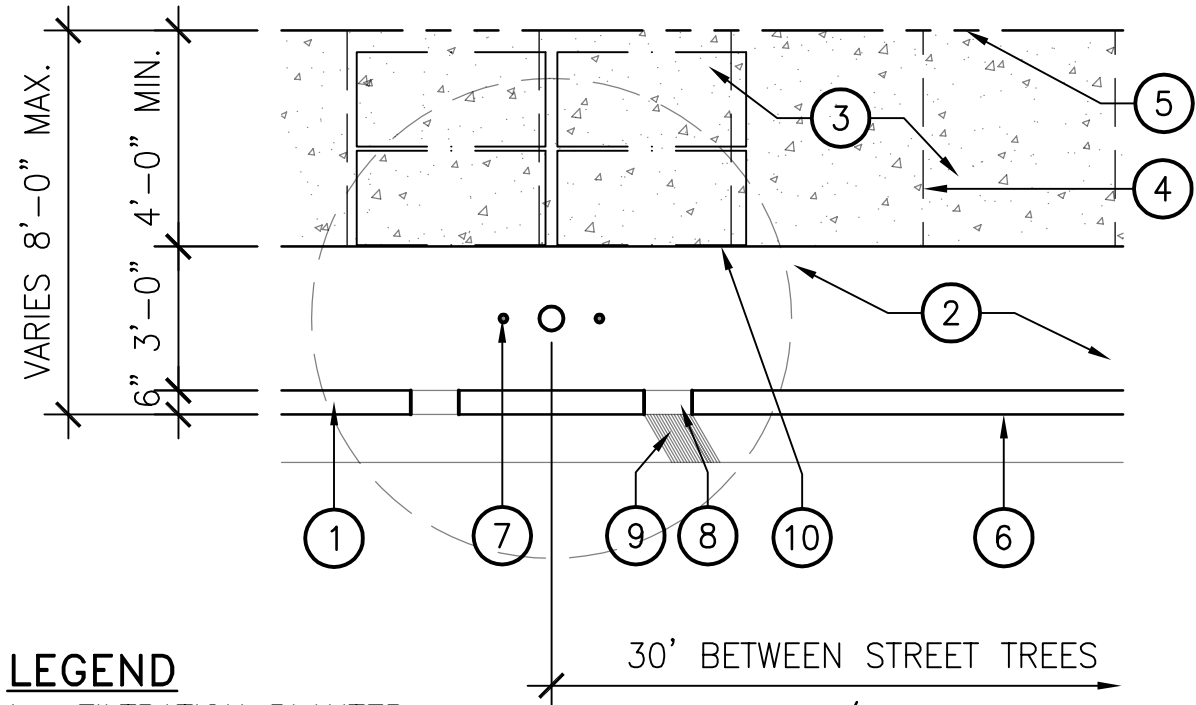

LEGEND

- | | |
|---|--|
| 1. FILTRATION PLANTER. | 8. CURB IN/OUTLET; FREQUENCY & LOCATION PER PROJECT CIVIL ENGINEERS. |
| 2. PLANTING AREA: MATERIAL PER MASTER PLAN. | 9. GUTTER GROOVES, ON UPHILL SIDE ONLY. |
| 3. CONCRETE: NATURAL GRAY, TOP-CAST #5. | 10. SILVA CELLS BY DEEPROOT. |
| 4. CONCRETE JOINT TYP. | |
| 5. RIGHT OF WAY/FACE OF BUILDING. | |
| 6. FACE OF CURB. | |
| 7. TREE STAKING. | |

NOTES

- A. PROVIDE 5' O.C. SIDEWALK CONCRETE JOINTS BOTH WAYS UNLESS OTHERWISE NOTED.

8 NATIONAL/ROBERTSON + FILTRATION PLANTER
SCALE: 1/4" = 1'-0" 14022_National/Robertson + filtration planter plan.dwg

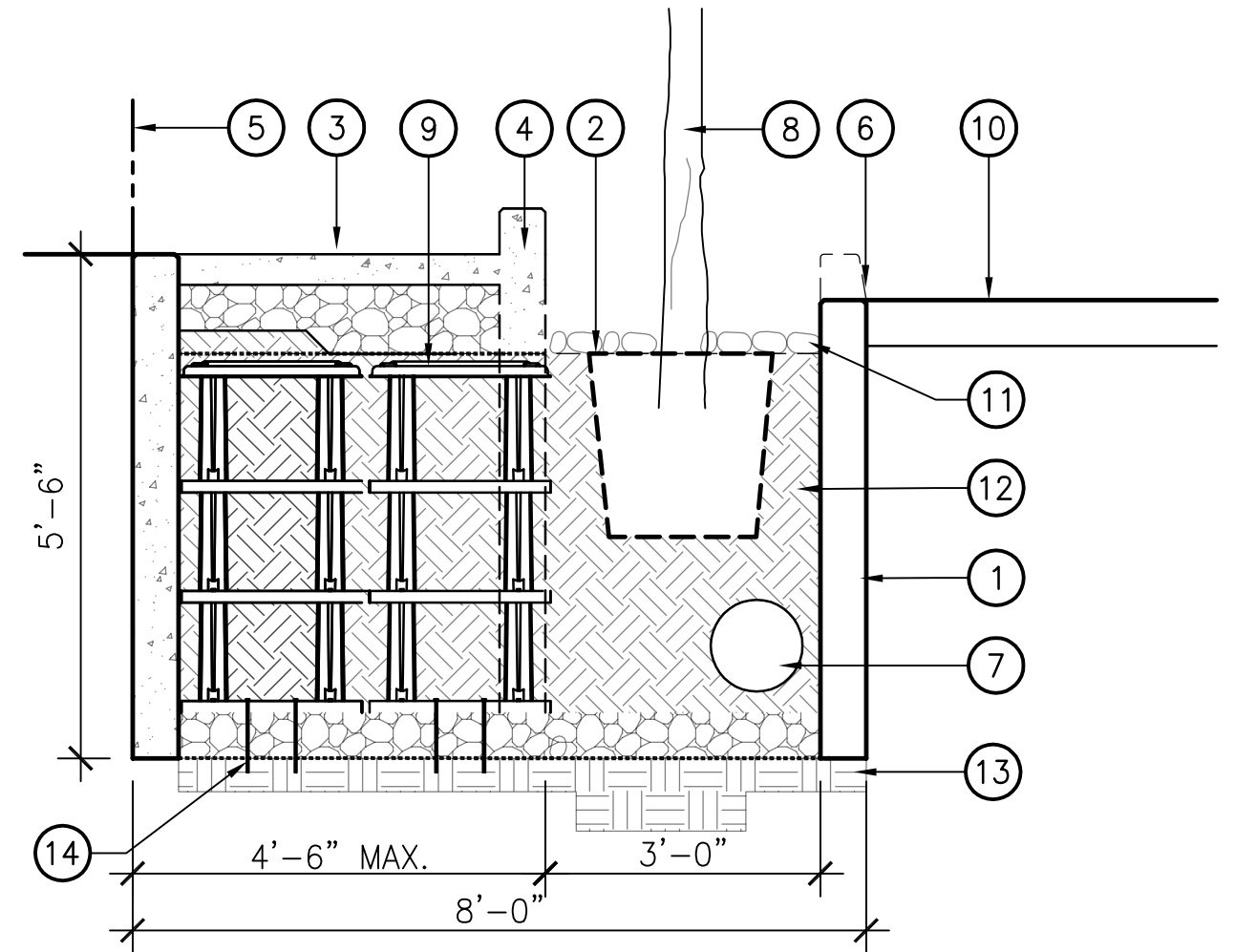

LEGEND

- | | |
|--|---|
| 1. FILTRATION PLANTER. | 8. 24" BOX STREET TREE. |
| 2. PLANTING AREA: MATERIAL PER MASTER PLAN. | 9. SILVA CELL BY DEEPROOT. |
| 3. CONCRETE: NATURAL GRAY, TOP-CAST #5. | 10. ROADWAY. |
| 4. RAISED CURB. | 11. WASHED RIVER COBBLE MULCH. |
| 5. RIGHT OF WAY. | 12. PLANTING SOIL |
| 6. FACE OF CURB. | 13. SUBGRADE COMPACTED PER GEOTECHNICAL REPORT. |
| 7. 12" Ø PLANTER PIPE, CONNECT TO STORM DRAIN, CONFIRM WITH PROJECT CIVIL ENGINEER | 14. 10" SPIKES |

NOTE:

- A. TREE STAKES NOT SHOWN FOR GRAPHIC CLARITY.

9 NATIONAL/ROBERTSON + FILTRATION PLANTER
SCALE: 1/2" = 1'-0" 114022_national/robertson + filtration planter.dwg

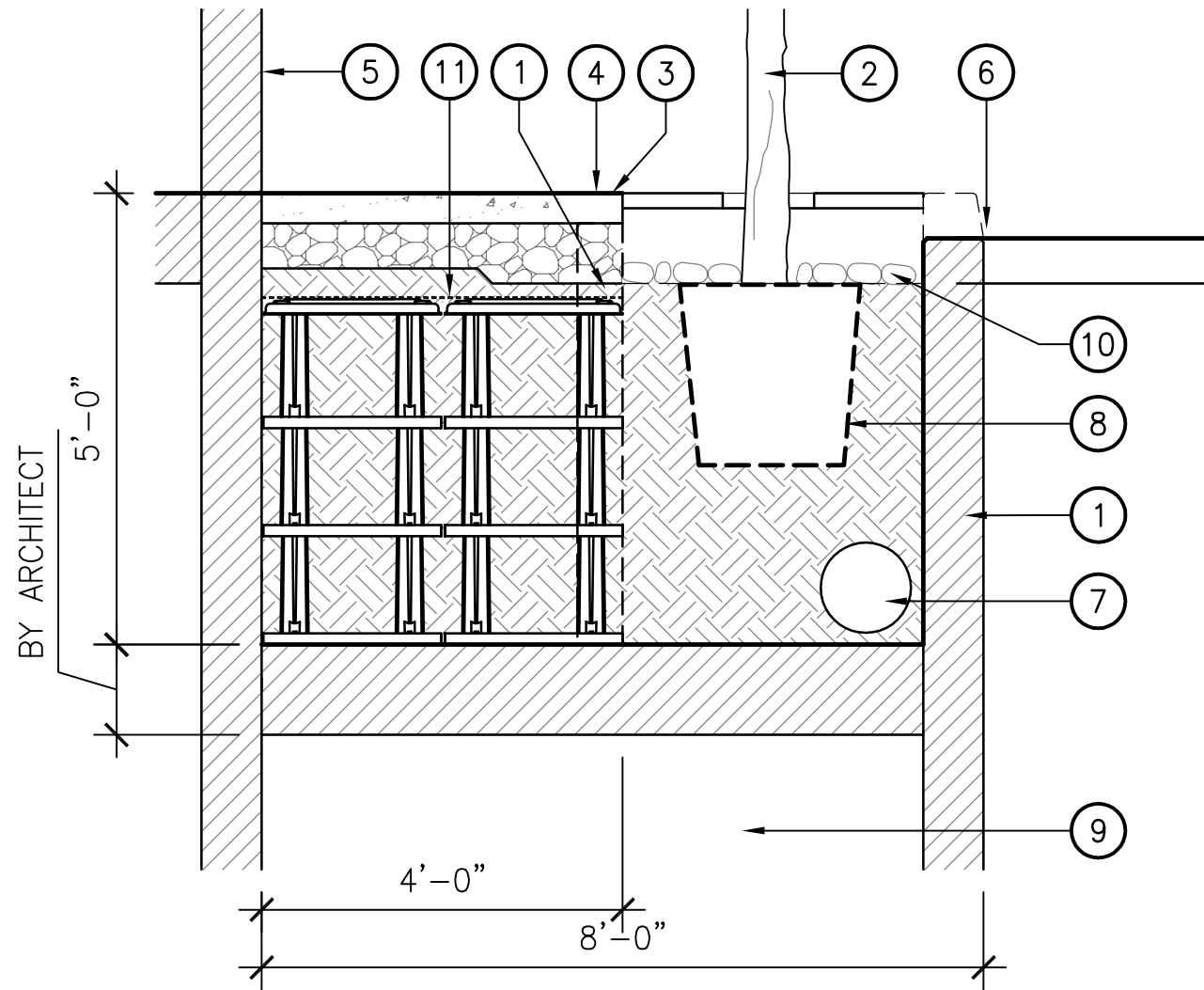

LEGEND

- | | |
|---|--|
| 1. FILTRATION PLANTER. | 7. 12" ϕ PLANTER DRAIN,CONNECT TO STORM DRAIN; CONFIRM WITH PROJECT CIVIL ENGINEER. |
| 2. 24" BOX STREET TREE. | 8. TREE ROOT BALL. |
| 3. CONCRETE: NATURAL GRAY, TOP-CAST #5. | 9. PARKING STRUCTURE BELOW, CLEAR SPACE FOR PARKED CAR. |
| 4. TREE GRATE. | 10. WASHED RIVER COBBLE MULCH. |
| 5. FACE OF BUILDING. | 11. GEOTEXTILE FABRIC |
| 6. FACE OF CURB. | |

10 NATIONAL + PARKING GARAGE
SCALE: 1/2" = 1'-0" 114022_National + parking garage.dwg

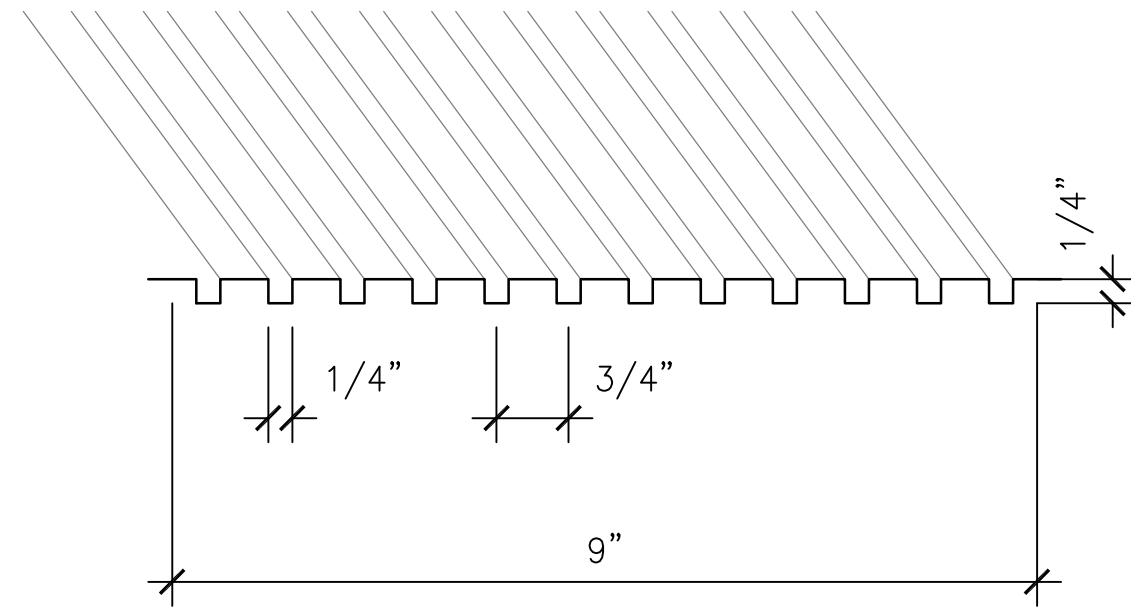

NOTES

- A. INSTALLED WHERE SHOWN ON PLAN.

11 GUTTER GROOVES
SCALE: 6" = 1'-0" 114022_Gutter Grooves.dwg

WESLEY STREET



Lomandra longifolia 'Breeze' / Breeze Lomandra



Bauhinia purpurea / Purple Orchid Tree



Lagerstroemia fauriei 'Natchez' / 'Natchez' Crape Myrtle



Cercidium x 'Desert Museum' / Desert Museum Palo Verde



Spathodea campanulata / African Tulip Tree

Wesley Street is planned to maintain its current neighborhood-scale pedestrian character and will take advantage of amenities and open space in the district.

The right-of-way along Wesley Street is 8 feet wide. The sidewalk will be a natural gray concrete with Top-Cast #5 finish.

Medium sized flowering street trees such as *Bauhinia purpurea* or *Cercidium x 'Desert Museum'* or *Lagerstroemia indica x fauriei 'Natchez'* or *Spathodea campanulata* will be planted at a maximum of 30 feet on center in a planted parkway. *Lomandra longifolia* 'Breeze' will be planted below the trees.



VIEW LOOKING NORTH ON WESLEY STREET

STREETScape PLAN

Note: Final bike lane configuration and bike box locations will be subject to final determination by the Public Works Director. The Plan may be modified to accommodate required bus stops/zones and associated bus stop components in coordination with the Transportation Department.

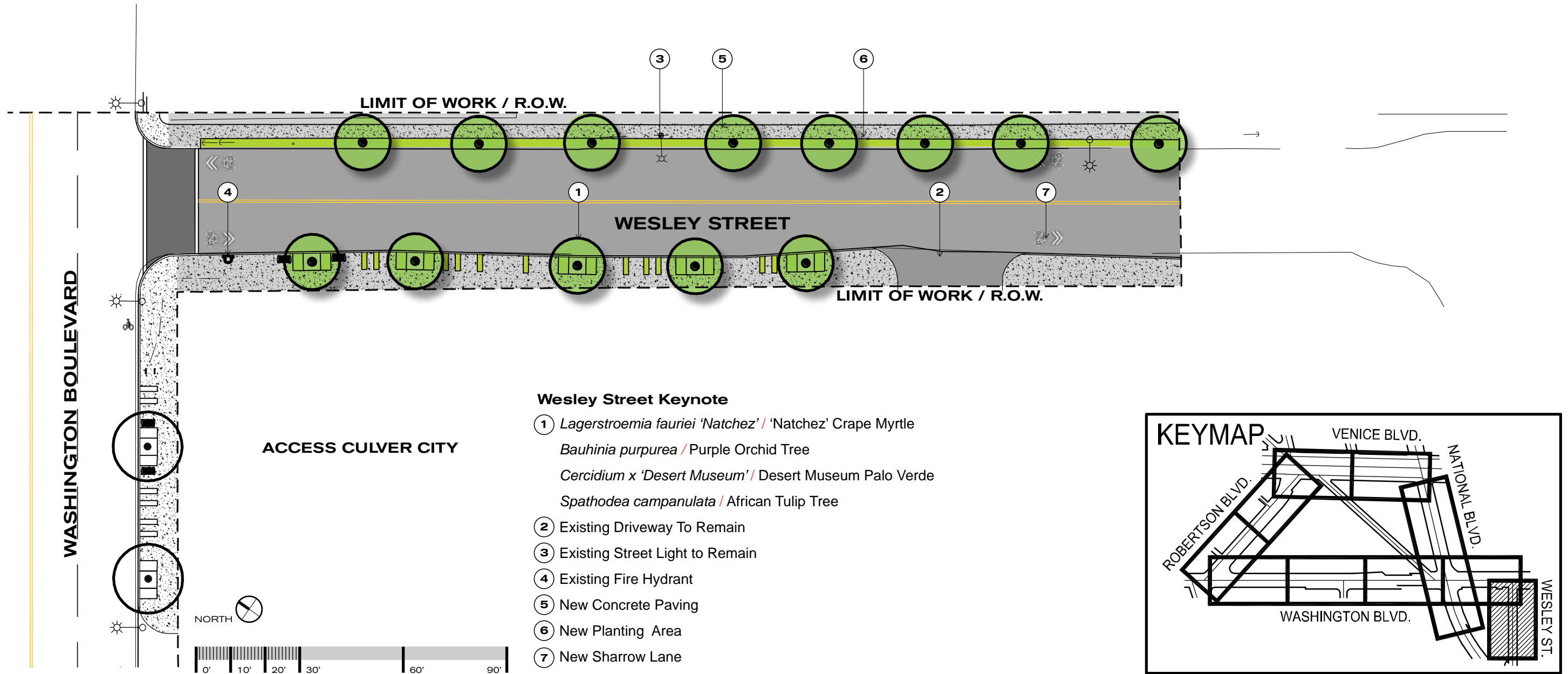

DETAILS

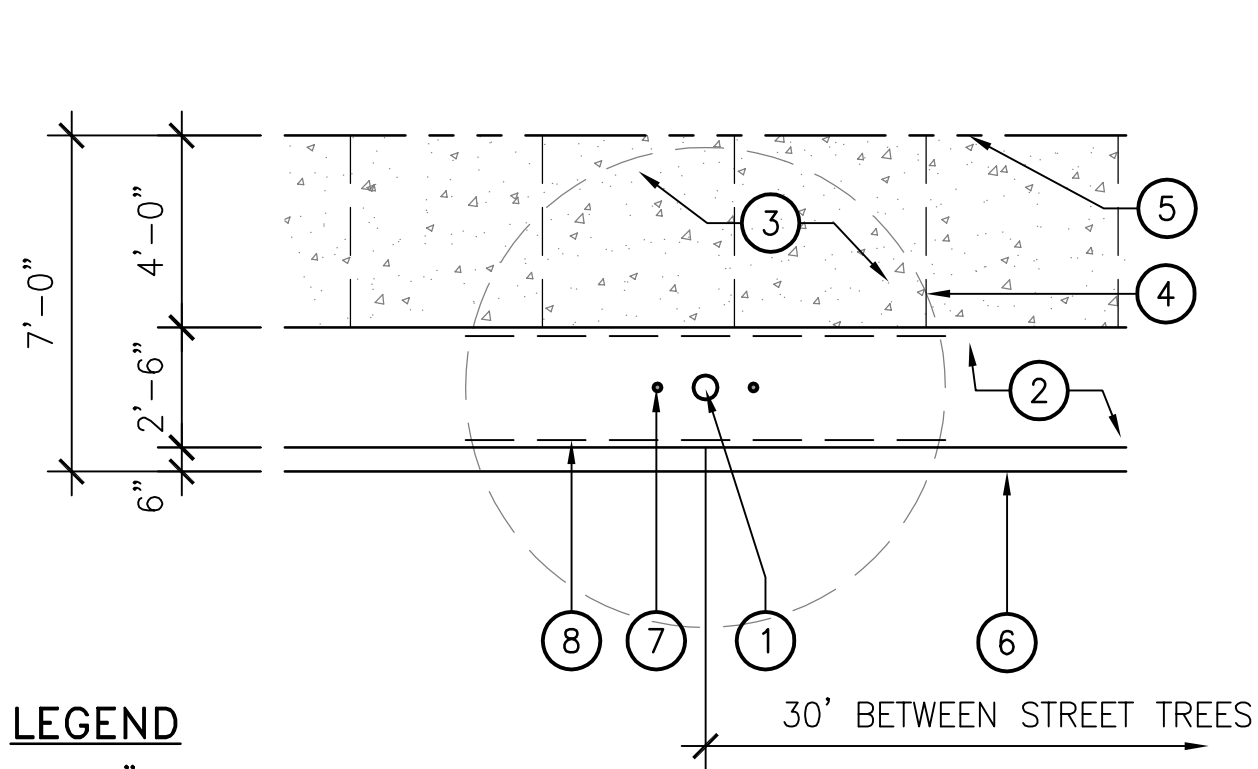

LEGEND

- 1. 24" BOX STREET TREE.
- 2. PLANTING AREA: MATERIAL PER MASTER PLAN.
- 3. CONCRETE: NATURAL GRAY, TOP-CAST #5.
- 4. CONCRETE JOINT TYP.
- 5. RIGHT OF WAY/FACE OF BUILDING.
- 6. FACE OF CURB.
- 7. TREE STAKING.
- 8. ROOT BARRIER.

NOTES

- A. PROVIDE 4' O.C. SIDEWALK CONCRETE JOINTS BOTH WAYS UNLESS OTHERWISE NOTED.

12 NEIGHBORHOOD STREET (WESLEY STREET)
SCALE: 1/4" = 1'-0" 114022_Wesley plan.dwg

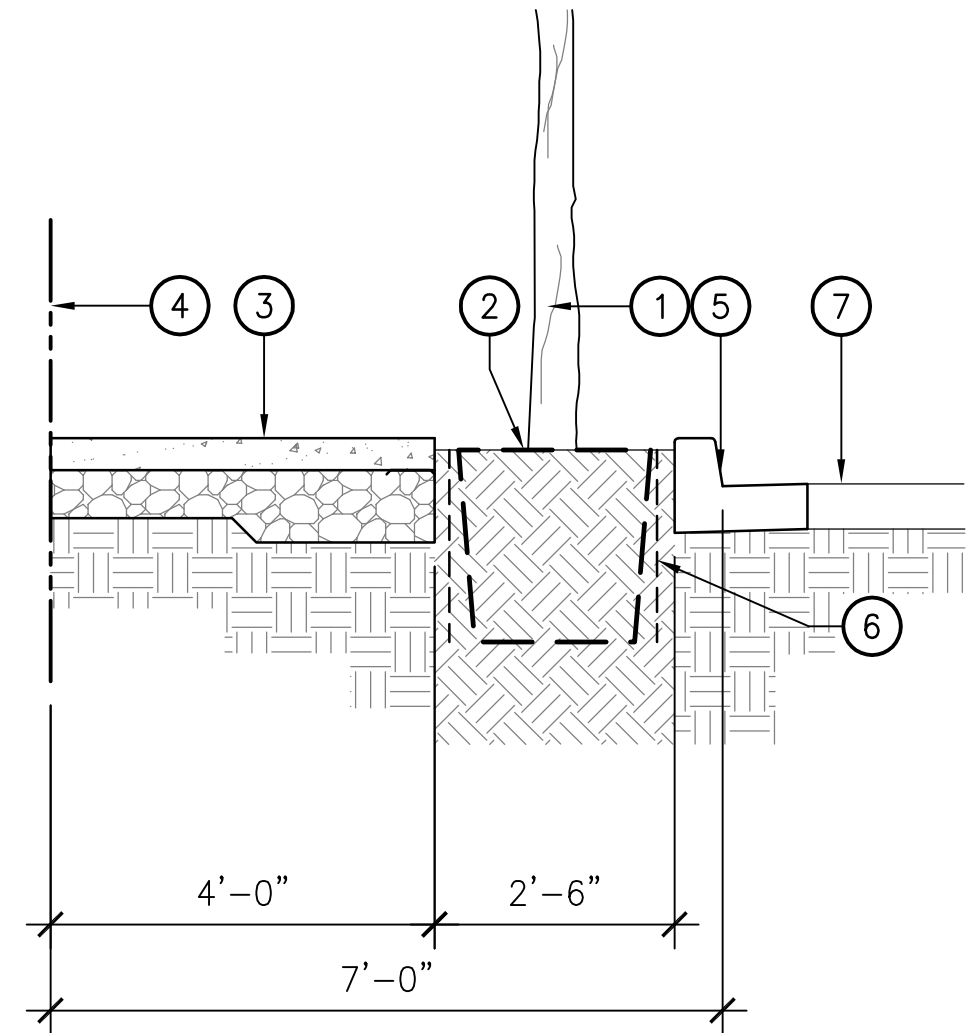

LEGEND

- 1. 24" BOX STREET TREE.
- 2. PLANTING AREA: MATERIAL PER MASTER PLAN.
- 3. CONCRETE: NATURAL GRAY, TOP-CAST #5.
- 4. RIGHT OF WAY.
- 5. FACE OF CURB.
- 6. ROOT BARRIER.
- 7. ROADWAY.

13 NEIGHBORHOOD STREET (WESLEY STREET)
SCALE: 1/2" = 1'-0" 114022_national + filtration planter.dwg

DISTRICT IDENTITY SIGNAGE



DIRECTORY / STREET BANNERS



AHBE Landscape Architects
Washington National Streetscape Plan
Preliminary Statement of Potential Project Budget
 Prepared by AHBE Landscape Architects: 1/26/2016

Washington National Streetscape Plan Area											GRAND TOTAL	\$4,807,635.27
											PRORATES	
	Unit	Quantity	Unit Cost	Subtotal	Design Contingency (20%)	Mobilization (8.5%)	Bonds + Insurance (2%)	Contractor's Fee (8.5%)	Contingency (2%)	Item Total		
SITE DEMOLITION												
Tree Removal Including Stump	each	62	\$1,250.00	\$77,500.00	\$15,500.00	\$6,587.50	\$1,550.00	\$6,587.50	\$1,550.00	\$109,275.00		
Sawcut and Remove Existing 4" P.C.C. Sidewalk	s.f.	69,360	\$3.00	\$208,080.00	\$41,616.00	\$17,686.80	\$4,161.60	\$17,686.80	\$4,161.60	\$293,392.80		
Unclassified Excavation - Proposed Planting Areas - 24" Depth	c.y.	168	\$60.00	\$10,055.56	\$2,011.11	\$854.72	\$201.11	\$854.72	\$201.11	\$14,178.33		
Unclassified Excavation - Proposed Planting Areas - 36" Depth	c.y.	19	\$60.00	\$1,120.00	\$224.00	\$95.20	\$22.40	\$95.20	\$22.40	\$1,579.20		
Unclassified Excavation - Filtration Planters	c.y.	5,113	\$60.00	\$306,780.00	\$61,356.00	\$26,076.30	\$6,135.60	\$26,076.30	\$6,135.60	\$432,559.80		
Unclassified Excavation - Proposed Pedestrian Concrete	c.y.	677	\$60.00	\$40,625.19	\$8,125.04	\$3,453.14	\$812.50	\$3,453.14	\$812.50	\$57,281.51		
											\$908,266.64	
SITE EARTHWORK												
Top Soil - Planting Areas - 24" Depth	c.y.	901	\$45.00	\$40,541.67	\$8,108.33	\$3,446.04	\$810.83	\$3,446.04	\$810.83	\$57,163.75		
Top Soil - Planting Areas - 36" Depth	c.y.	79	\$45.00	\$3,560.00	\$712.00	\$302.60	\$71.20	\$302.60	\$71.20	\$5,019.60		
Top Soil - Filtration Planters	c.y.	5,113	\$45.00	\$230,085.00	\$46,017.00	\$19,557.23	\$4,601.70	\$19,557.23	\$4,601.70	\$324,419.85		
Fine Grading Including Soil Preparation, Excavation, Amendments	s.f.	15,282	\$3.50	\$53,487.00	\$10,697.40	\$4,546.40	\$1,069.74	\$4,546.40	\$1,069.74	\$75,416.67		
Erosion Control / SWPPP	s.f.	73,240	\$0.10	\$7,324.00	\$1,464.80	\$622.54	\$146.48	\$622.54	\$146.48	\$10,326.84		
Soil Testing	each	10	\$250.00	\$2,500.00	\$500.00	\$212.50	\$50.00	\$212.50	\$50.00	\$3,525.00		
											\$475,871.71	
SITE PAVEMENT												
6" Concrete Curb and Gutter	l.f.	6,670	\$35.00	\$233,450.00	\$46,690.00	\$19,843.25	\$4,669.00	\$19,843.25	\$4,669.00	\$329,164.50		
Sidewalk, Integral Color Concrete	s.f.	54,844	\$12.00	\$658,128.00	\$131,625.60	\$55,940.88	\$13,162.56	\$55,940.88	\$13,162.56	\$927,960.48		
Sidewalk, Concrete Unit Pavers	s.f.	2,158	\$15.00	\$32,370.00	\$6,474.00	\$2,751.45	\$647.40	\$2,751.45	\$647.40	\$45,641.70		
Filtration Planter Walls	c.y.	858	\$80.00	\$68,640.00	\$13,728.00	\$5,834.40	\$1,372.80	\$5,834.40	\$1,372.80	\$96,782.40		
6" Concrete Curb	l.f.	2,325	\$20.00	\$46,500.00	\$9,300.00	\$3,952.50	\$930.00	\$3,952.50	\$930.00	\$65,565.00		
											\$1,465,114.08	
CROSSWALKS												
Washington Boulevard & National Boulevard - 4 Legs	allow	1	\$124,262.00	\$124,262.00	\$24,852.40	\$10,562.27	\$2,485.24	\$10,562.27	\$2,485.24	\$175,209.42		
Washington Boulevard & Landmark Street - 3 Legs	allow	1	\$75,000.00	\$75,000.00	\$15,000.00	\$6,375.00	\$1,500.00	\$6,375.00	\$1,500.00	\$105,750.00		
Washington Boulevard & Wesley Street - 1 Leg	allow	1	\$12,280.00	\$12,280.00	\$2,456.00	\$1,043.80	\$245.60	\$1,043.80	\$245.60	\$17,314.80		
Venice Boulevard & National Boulevard - 1 Leg	allow	1	\$44,604.00	\$44,604.00	\$8,920.80	\$3,791.34	\$892.08	\$3,791.34	\$892.08	\$62,891.64		
											\$361,165.86	
SITE FURNITURE												
Tree Grates (Ironsmith 4x6 "Market Street" + BlackMax + Frame)	each	52	\$1,500.00	\$78,000.00	\$15,600.00	\$6,630.00	\$1,560.00	\$6,630.00	\$1,560.00	\$109,980.00		
Bike Racks (Simple-Lok)	each	8	\$500.00	\$4,000.00	\$800.00	\$340.00	\$80.00	\$340.00	\$80.00	\$5,640.00		
Dual Use Little Receptacle (Landscape Forms "Scarborough")	each	8	\$1,750.00	\$14,000.00	\$2,800.00	\$1,190.00	\$280.00	\$1,190.00	\$280.00	\$19,740.00		
Benches (Landscape Forms "Towne Square")	each	15	\$1,250.00	\$18,750.00	\$3,750.00	\$1,593.75	\$375.00	\$1,593.75	\$375.00	\$26,437.50		
											\$161,797.50	
SITE PLANTING												
24" Box, Canopy Tree	each	54	\$500.00	\$27,000.00	\$5,400.00	\$2,295.00	\$540.00	\$2,295.00	\$540.00	\$38,070.00		
36" Box, Canopy Tree	each	69	\$1,100.00	\$75,900.00	\$15,180.00	\$6,451.50	\$1,518.00	\$6,451.50	\$1,518.00	\$107,019.00		
1 Gallon, Shrub/GC, 18" o.c.	s.f.	16,238	\$12.00	\$194,856.00	\$38,971.20	\$16,562.76	\$3,897.12	\$16,562.76	\$3,897.12	\$274,746.96		
Silva Cell	each	2,712	\$150.00	\$406,800.00	\$81,360.00	\$34,578.00	\$8,136.00	\$34,578.00	\$8,136.00	\$573,588.00		
Weed Control	s.f.	16,238	\$0.25	\$4,059.50	\$811.90	\$345.06	\$81.19	\$345.06	\$81.19	\$5,723.90		
Mulch for Planting Areas	s.f.	16,238	\$1.25	\$20,297.50	\$4,059.50	\$1,725.29	\$405.95	\$1,725.29	\$405.95	\$28,619.48		
90 Day Maintenance	s.f.	16,238	\$1.00	\$16,238.00	\$3,247.60	\$1,380.23	\$324.76	\$1,380.23	\$324.76	\$22,895.58		
											\$1,012,592.91	

SITE IRRIGATION	Unit	Quantity	Unit Cost	Subtotal	Design Contingency (20%)	Mobilization (8.5%)	Bonds + Insurance (2%)	Contractor's Fee (8.5%)	Contingency (2%)	Item Total
Drip Irrigation (Planting Areas)	each	16,238	\$4.00	\$64,952.00	\$12,990.40	\$5,520.92	\$1,299.04	\$5,520.92	\$1,299.04	\$91,582.32
Tree Bubblers	each	123	\$75.00	\$9,225.00	\$1,845.00	\$784.13	\$184.50	\$784.13	\$184.50	\$13,007.25
Remote Control Valves	each	20	\$750.00	\$15,000.00	\$3,000.00	\$1,275.00	\$300.00	\$1,275.00	\$300.00	\$21,150.00
Smart Irrigation Controller + Cabinet	each	5	\$6,500.00	\$32,500.00	\$6,500.00	\$2,762.50	\$650.00	\$2,762.50	\$650.00	\$45,825.00
Irrigation POC + Water Meter	each	5	\$9,000.00	\$45,000.00	\$9,000.00	\$3,825.00	\$900.00	\$3,825.00	\$900.00	\$63,450.00
										\$235,014.57
WAYFINDING	Unit	Quantity	Unit Cost	Subtotal	Design Contingency (20%)	Mobilization (8.5%)	Bonds + Insurance (2%)	Contractor's Fee (8.5%)	Contingency (2%)	Item Total
Sign Type 1, District ID on Light Post	each	44	\$1,000.00	\$44,000.00	\$8,800.00	\$3,740.00	\$880.00	\$3,740.00	\$880.00	\$62,040.00
Sign Type 1, Dual Banners on Light Post	each	44	\$300.00	\$13,200.00	\$2,640.00	\$1,122.00	\$264.00	\$1,122.00	\$264.00	\$18,612.00
Sign Type 2, Pedestrian Directory	each	4	\$9,000.00	\$36,000.00	\$7,200.00	\$3,060.00	\$720.00	\$3,060.00	\$720.00	\$50,760.00
Sign Type 3, Pedestrian Direction Sign	each	10	\$4,000.00	\$40,000.00	\$8,000.00	\$3,400.00	\$800.00	\$3,400.00	\$800.00	\$56,400.00
										\$187,812.00

APPENDIX



Geotechnologies, Inc.
 Consulting Geotechnical Engineers
 439 Western Avenue
 Glendale, California 91201-2837
 818.240.9600 • Fax 818.240.9675

July 9, 2014
 File No. 20784

AHBE Landscape Architects
 617 West Seventh Street, Suite 304
 Los Angeles, California 90017

Attention: Evan Mather

Subject: Geotechnical Engineering Investigation
 Proposed Streetscape Plan
 Southeast Corner of Washington Boulevard & National Boulevard
 Culver City, California

Ladies and Gentlemen:

This letter transmits the Geotechnical Engineering Investigation for the subject property prepared by Geotechnologies, Inc. This report provides geotechnical recommendations for the development of the site, including earthwork, seismic design, excavations and foundation design. Engineering for the proposed project should not begin until approval of the geotechnical investigation is granted by the local building official. Significant changes in the geotechnical recommendations may result due to the building department review process.

The validity of the recommendations presented herein is dependent upon review of the geotechnical aspects of the project during construction by this firm. The subsurface conditions described herein have been projected from limited subsurface exploration and laboratory testing. The exploration and testing presented in this report should in no way be construed to reflect any variations which may occur between the exploration locations or which may result from changes in subsurface conditions.

Should you have any questions please contact this office.

Respectfully submitted,
 GEOTECHNOLOGIES, INC.

 SCOTT T. PRINCE
 Staff Engineer

 EDWARD F. HILL
 G.E. 2126

STP/EFH:sa

Distribution: (3) Addressee

Email to: Evan Mather [emather@ahbe.com]

www.geoteq.com

TABLE OF CONTENTS

<u>SECTION</u>	<u>PAGE</u>
INTRODUCTION	1
PROPOSED DEVELOPMENT	1
SITE CONDITIONS	2
GEOTECHNICAL EXPLORATION	2
FIELD EXPLORATION	2
Geologic Materials	3
Groundwater	3
Caving	4
SEISMIC EVALUATION	4
REGIONAL GEOLOGIC SETTING	4
REGIONAL FAULTING	5
SEISMIC HAZARDS AND DESIGN CONSIDERATIONS	5
Surface Rupture	6
Liquefaction	6
Tsunamis, Seiches and Flooding	7
Landsliding	7
CONCLUSIONS AND RECOMMENDATIONS	7
SEISMIC DESIGN CONSIDERATIONS	8
2013 California Building Code Seismic Parameters	8
FILL SOILS	9
EXPANSIVE SOILS	9
WATER-SOLUBLE SULFATES	10
GRADING GUIDELINES	10
Compaction	11
Acceptable Materials	11
Utility Trench Backfill	12
Wet Soils	12
Shrinkage	13
Weather Related Grading Considerations	13
Abandoned Seepage Pits	14
Geotechnical Observations and Testing During Grading	14
LEED Considerations	15
FOUNDATION DESIGN	16
Miscellaneous Conventional Foundations	16
Foundation Reinforcement	17
Lateral Design	17
Foundation Settlement	18
Foundation Observations	18
TEMPORARY EXCAVATIONS	18
Excavation Observations	19
SLABS ON GRADE	19
Concrete Slabs-on Grade	19
Concrete Crack Control	20



Geotechnologies, Inc.
 439 Western Avenue, Glendale, California 91201-2837 • Tel: 818.240.9600 • Fax: 818.240.9675
 www.geoteq.com

TABLE OF CONTENTS

<u>SECTION</u>	<u>PAGE</u>
Slab Reinforcing	20
PAVEMENTS.....	21
SITE DRAINAGE	23
STORMWATER DISPOSAL	23
Introduction.....	23
Percolation Testing	24
The Proposed System.....	24
Recommendations.....	25
DESIGN REVIEW	25
CONSTRUCTION MONITORING	26
EXCAVATION CHARACTERISTICS.....	26
CLOSURE AND LIMITATIONS.....	27
GEOTECHNICAL TESTING.....	28
Classification and Sampling	28
Expansion Index Testing.....	28
Laboratory Compaction Characteristics	29
 ENCLOSURES	
References	
Vicinity Map	
Plot Plan	
Historically Highest Groundwater Levels	
Seismic Hazard Zone Map	
Plate A	
Plate D	



Geotechnologies, Inc.
 439 Western Avenue, Glendale, California 91201-2837 • Tel: 818.240.9600 • Fax: 818.240.9675
www.geoteq.com

**GEOTECHNICAL ENGINEERING INVESTIGATION
 PROPOSED STREETScape PLAN
 SOUTHEAST CORNER OF WASHINGTON BOULEVARD AND NATIONAL
 BOULEVARD
 CULVER CITY, CALIFORNIA**

INTRODUCTION

This report presents the results of the geotechnical engineering investigation performed on the subject site. The purpose of this investigation was to identify the distribution and engineering properties of the geologic materials underlying the site, and to provide geotechnical recommendations for the design of the proposed development.

This investigation included one exploratory excavation, collection of representative samples, laboratory testing, engineering analysis, review of published geologic data, review of available geotechnical engineering information and the preparation of this report. The exploratory excavation location is shown on the enclosed Plot Plan. The results of the exploration and the laboratory testing are presented in the Appendix of this report.

PROPOSED DEVELOPMENT

Information concerning the proposed development was furnished by the client. The proposed development consists of a streetscape plan. The streetscape area is proposed to provide trees, bike racks, benches, trash receptacles, paving, and street graphics. Only lightly-loaded uninhabitable structures are anticipated for the project. All facilities are planned to be built at existing site grade. Grading will consist of removal and recompaction of existing unsuitable soils. The final location of the proposed uninhabitable structures should be reviewed by this firm once final plans are

439 Western Avenue, Glendale, California 91201-2837 • 818.240.9600 • 818.240.9675 fax
www.geoteq.com

July 9, 2014
File No. 20784
Page 2

available. The recommendations contained in this report should not be considered valid until reviewed and modified or reaffirmed, in writing, subsequent to such review.

SITE CONDITIONS

The proposed streetscape plan is located at the southerly corner of Washington Boulevard and National Boulevard in Culver City, California. The site is triangular in shape, and approximately 0.10 acres in area. The site is bounded by Washington Boulevard to the northwest, National Boulevard to the northeast, and an elevated rail transit structure to the south.

The subject site is relatively level, with no pronounced highs or lows. The site is currently unoccupied. Vegetation on the site consists of grass and trees. Drainage appears to be by sheetflow to the city streets.

GEOTECHNICAL EXPLORATION

FIELD EXPLORATION

The site was explored on June 13, 2014 by performing one exploratory excavation. The excavation carried to a depth of 6 feet with the aid of hand tools. The upper reaches of the excavation was on the order of 5 feet square. The exploration location is shown on the Plot Plan and the geologic materials encountered are logged on Plate A.

The location of the exploratory excavation was determined from hardscape features shown on the attached Plot Plan. The location of the exploratory excavation should be considered accurate only to the degree implied by the method used.



Geotechnologies, Inc.
439 Western Avenue, Glendale, California 91201-2837 • Tel: 818.240.9600 • Fax: 818.240.9675
www.geoteq.com

July 9, 2014
File No. 20784
Page 3

Geologic Materials

Fill materials were encountered in the exploratory excavation to depths of 4 feet below the existing site grade. Fill materials encountered in the exploratory excavation consist of a mixture of fine grained silty sand to sand. The fill ranges from medium to dark to yellowish brown in color, and is moist, and medium dense.

The fill is underlain by alluvial soils consisting of interlayered mixtures of sandy silt to clayey silt. The alluvial soils range in color from brown to dark brown, moist, stiff, and fine grained. More detailed descriptions of the earth materials encountered may be obtained from individual logs of the subsurface excavations.

Groundwater

Groundwater was not encountered during exploration to a depth of 6 feet. The historic high groundwater level was established by review of California Geological Survey Seismic Hazard Evaluation Report 023 Plate 1.2 entitled "Historically Highest Ground Water Contours". Review of this plate indicates that the historically highest groundwater level was on the order of 18 feet below grade. A copy of this plate is included in the Appendix as Historically Highest Groundwater Levels Map.

Fluctuations in the level of groundwater may occur due to variations in rainfall, temperature, and other factors not evident at the time of the measurements reported herein. Fluctuations also may occur across the site. High groundwater levels can result in changed conditions.



Geotechnologies, Inc.
439 Western Avenue, Glendale, California 91201-2837 • Tel: 818.240.9600 • Fax: 818.240.9675
www.geoteq.com

July 9, 2014
File No. 20784
Page 4

Caving

Caving could not be directly observed during exploration due to the type of excavation equipment utilized. Based on the experience of this firm, large diameter excavations that encounter granular, cohesionless soils, and excavations below the groundwater table, will most likely experience caving.

SEISMIC EVALUATION

REGIONAL GEOLOGIC SETTING

The subject property is located in the Los Angeles Basin. The Los Angeles Basin is located at the northern end of the Peninsular Ranges Geomorphic Province. The basin is bounded by the east and southeast by the Santa Ana Mountains and San Joaquin Hills, to the northwest by the Santa Monica Mountains. Over 22 million years ago the Los Angeles basin was a deep marine basin formed by tectonic forces between the North American and Pacific plates. Since that time, over 5 miles of marine and non-marine sedimentary rock as well as intrusive and extrusive igneous rocks have filled the basin. During the last 2 million years, defined by the Pleistocene and Holocene epochs, the Los Angeles basin and surrounding mountain ranges have been uplifted to form the present day landscape. Erosion of the surrounding mountains has resulted in deposition of unconsolidated sediments in low-lying areas by rivers such as the Los Angeles River. Areas that have experienced subtle uplift have been eroded with gullies.



Geotechnologies, Inc.
439 Western Avenue, Glendale, California 91201-2837 • Tel: 818.240.9600 • Fax: 818.240.9675
www.geoteq.com

July 9, 2014
File No. 20784
Page 5

REGIONAL FAULTING

Based on criteria established by the California Division of Mines and Geology (CDMG) now called California Geologic Survey (CGS), faults may be categorized as active, potentially active, or inactive. Active faults are those which show evidence of surface displacement within the last 11,000 years (Holocene-age). Potentially-active faults are those that show evidence of most recent surface displacement within the last 1.6 million years (Quaternary-age). Faults showing no evidence of surface displacement within the last 1.6 million years are considered inactive for most purposes, with the exception of design of some critical structures.

Buried thrust faults are faults without a surface expression but are a significant source of seismic activity. They are typically broadly defined based on the analysis of seismic wave recordings of hundreds of small and large earthquakes in the southern California area. Due to the buried nature of these thrust faults, their existence is usually not known until they produce an earthquake. The risk for surface rupture potential of these buried thrust faults is inferred to be low (Leighton, 1990). However, the seismic risk of these buried structures in terms of recurrence and maximum potential magnitude is not well established. Therefore, the potential for surface rupture on these surface-verging splays at magnitudes higher than 6.0 cannot be precluded.

SEISMIC HAZARDS AND DESIGN CONSIDERATIONS

The primary geologic hazard at the site is moderate to strong ground motion (acceleration) caused by an earthquake on any of the local or regional faults. The potential for other earthquake-induced hazards was also evaluated including surface rupture, liquefaction, dynamic settlement, inundation and landsliding.



Geotechnologies, Inc.
439 Western Avenue, Glendale, California 91201-2837 • Tel: 818.240.9600 • Fax: 818.240.9675
www.geoteq.com

July 9, 2014
File No. 20784
Page 6

Surface Rupture

In 1972, the Alquist-Priolo Special Studies Zones Act (now known as the Alquist-Priolo Earthquake Fault Zoning Act) was passed into law. The Act defines “active” and “potentially active” faults utilizing the same aging criteria as that used by California Geological Survey (CGS). However, established state policy has been to zone only those faults which have direct evidence of movement within the last 11,000 years. It is this recency of fault movement that the CGS considers as a characteristic for faults that have a relatively high potential for ground rupture in the future.

CGS policy is to delineate a boundary from 200 to 500 feet wide on each side of the known fault trace based on the location precision, the complexity, or the regional significance of the fault. If a site lies within an Earthquake Fault Zone, a geologic fault rupture investigation must be performed that demonstrates that the proposed building site is not threatened by surface displacement from the fault before development permits may be issued.

Ground rupture is defined as surface displacement which occurs along the surface trace of the causative fault during an earthquake. Based on research of available literature and results of site reconnaissance, no known active or potentially active faults underlie the subject site. In addition, the subject site is not located within an Alquist-Priolo Earthquake Fault Zone. Based on these considerations, the potential for surface ground rupture at the subject site is considered low.

Liquefaction

Liquefaction is a phenomenon in which saturated silty to cohesionless soils below the groundwater table are subject to a temporary loss of strength due to the buildup of excess pore pressure during cyclic loading conditions such as those induced by an earthquake. Liquefaction-related effects include loss of bearing strength, amplified ground oscillations, lateral spreading, and flow failures.



Geotechnologies, Inc.

439 Western Avenue, Glendale, California 91201-2837 • Tel: 818.240.9600 • Fax: 818.240.9675
www.geoteq.com

July 9, 2014
File No. 20784
Page 7

The Seismic Hazard Map for the Beverly Hills Quadrangle by the State of California (CDMG, 1999), classifies the site as part of a “Liquefiable” area. This determination is based on groundwater depth records, soil type and distance to a fault capable of producing a substantial earthquake. The proposed improvements are not habitable or subject to collapse therefore no recommendations have been made based on the liquefiable nature of the site.

Tsunamis, Seiches and Flooding

Tsunamis are large ocean waves generated by sudden water displacement caused by a submarine earthquake, landslide, or volcanic eruption. Review of the Culver City Tsunami Map indicates the site does not lie within the mapped tsunami inundation boundaries.

Seiches are large waves generated in enclosed bodies of water in response to ground shaking. Review of the Culver City Natural Hazards Fire and Flooding Map indicates the site does not lie within mapped inundation boundary due to a breach in the upgradient reservoir.

Landsliding

The probability of seismically-induced landslides occurring on the site is considered to be low due to the general lack of elevation difference across or adjacent to the site.

CONCLUSIONS AND RECOMMENDATIONS

Based upon the exploration, laboratory testing, and research, it is the finding of Geotechnologies, Inc. that construction of the proposed streetscape project is considered feasible from a geotechnical engineering standpoint provided the advice and recommendations presented herein are followed and implemented during construction.



Geotechnologies, Inc.

439 Western Avenue, Glendale, California 91201-2837 • Tel: 818.240.9600 • Fax: 818.240.9675
www.geoteq.com

July 9, 2014
 File No. 20784
 Page 8

The existing fill materials are not suitable for support of the proposed foundations. It is recommended that, as a minimum, the upper 12 inches of fill materials be scarified and recompacted for support of concrete flatwork. Miscellaneous structures may be supported on conventional foundations deepened through any existing fill to bear in the underlying alluvial soils.

The validity of the conclusions and design recommendations presented herein is dependent upon review of the geotechnical aspects of the proposed construction by this firm. The subsurface conditions described herein have been projected from excavations on the site as indicated and should in no way be construed to reflect any variations which may occur between these excavations or which may result from changes in subsurface conditions. Any changes in the design, as outlined in this report, should be reviewed by this office. The recommendations contained herein should not be considered valid until reviewed and modified or reaffirmed subsequent to such review.

SEISMIC DESIGN CONSIDERATIONS

2013 California Building Code Seismic Parameters

Based on information derived from the subsurface investigation, the subject site is classified as Site Class D, which corresponds to a “Stiff Soil” Profile, according to Table 1613.5.2 of the California Building Code. This information and the site coordinates were input into the USGS Ground Motion Parameter Calculator (Version 5.1.0) to calculate the Maximum Considered Earthquake (MCE) Ground Motions for the site. The Maximum Considered Earthquake Ground motions are equivalent to the 2475-year recurrence interval ground motions adjusted by a deterministic limit. Ground motion parameters for the 2013 CBC (ASCE 7-10) are presented below.



Geotechnologies, Inc.
 439 Western Avenue, Glendale, California 91201-2837 • Tel: 818.240.9600 • Fax: 818.240.9675
 www.geoteq.com

July 9, 2014
 File No. 20784
 Page 9

2013 CALIFORNIA BUILDING CODE SEISMIC PARAMETERS	
Site Class	D
Mapped Spectral Acceleration at Short Periods (S_s)	2.024g
Site Coefficient (F_a)	1.0
Maximum Considered Earthquake Spectral Response for Short Periods (S_{MS})	2.024g
Five-Percent Damped Design Spectral Response Acceleration at Short Periods (S_{DS})	1.350g
Mapped Spectral Acceleration at One-Second Period (S_1)	0.742g
Site Coefficient (F_v)	1.5
Maximum Considered Earthquake Spectral Response for One-Second Period (S_{M1})	1.114g
Five-Percent Damped Design Spectral Response Acceleration for One-Second Period (S_{D1})	0.742g

FILL SOILS

The maximum depth of fill encountered during exploration was 4 feet. The fill soils are not suitable for the support of foundations but may be reused as compacted fill. All foundations should penetrate the fill materials and bear in underlying native soils. Existing fill materials should be removed and recompacted a minimum of 12 inches for support of proposed concrete flatwork.

EXPANSIVE SOILS

The onsite geologic materials are in the moderate expansion range. The Expansion Index was found to be 50 for representative bulk samples. Recommended reinforcing is provided in the “Foundation Design” and “Slabs on Grade” sections of this report.



Geotechnologies, Inc.
 439 Western Avenue, Glendale, California 91201-2837 • Tel: 818.240.9600 • Fax: 818.240.9675
 www.geoteq.com

July 9, 2014
File No. 20784
Page 10

WATER-SOLUBLE SULFATES

The Portland cement portion of concrete is subject to attack when exposed to water-soluble sulfates. Usually the two most common sources of exposure are from soil and marine environments.

The sources of natural sulfate minerals in soils include the sulfates of calcium, magnesium, sodium, and potassium. When these minerals interact and dissolve in subsurface water, a sulfate concentration is created, which will react with exposed concrete. Over time sulfate attack will destroy improperly proportioned concrete well before the end of its intended service life.

The water-soluble sulfate content of the onsite geologic materials was tested by California Test 417. The water-soluble sulfate content was determined to be less than 0.1% percentage by weight for the soils tested. Based on American Concrete Institute (ACI) Standard 318-08, the sulfate exposure is considered to be negligible for geologic materials with less than 0.1% and Type I cement may be utilized for concrete foundations in contact with the site soils.

GRADING GUIDELINES

The following section is included for any miscellaneous grading that may be required, such as concrete flatwork subgrade preparation.

As a minimum, existing earth materials should be scarified to a minimum depth of 12 inches below the proposed subgrade of any outdoor concrete flatwork, moistened or dried to within 3 percent of optimum moisture content, and recompactd in excess of the minimum required comparative density.



Geotechnologies, Inc.

439 Western Avenue, Glendale, California 91201-2837 • Tel: 818.240.9600 • Fax: 818.240.9675
www.geoteq.com

July 9, 2014
File No. 20784
Page 11

Compaction

All fill should be mechanically compacted in layers not more than 8 inches thick. All fill shall be compacted to at least 90 percent of the maximum laboratory density for the materials used. The maximum density shall be determined by the laboratory operated by Geotechnologies, Inc. using the test method described in the most recent revision of ASTM D 1557.

Field observation and testing shall be performed by a representative of the geotechnical engineer during grading to assist the contractor in obtaining the required degree of compaction and the proper moisture content. Where compaction is less than required, additional compactive effort shall be made with adjustment of the moisture content, as necessary, until a minimum of 90 percent compaction is obtained.

Acceptable Materials

The excavated onsite materials are considered satisfactory for reuse in the controlled fills as long as any debris and/or organic matter is removed.

Any imported materials shall be observed and tested by the representative of the geotechnical engineer prior to use in fill areas. Imported materials should contain sufficient fines so as to be relatively impermeable and result in a stable subgrade when compacted. Any required import materials should consist of geologic materials with an expansion index of less than 50. The water-soluble sulfate content of the import materials should be less than 0.1% percentage by weight.

Imported materials should be free from chemical or organic substances which could affect the proposed development. A competent professional should be retained in order to test imported materials and address environmental issues and organic substances which might affect the proposed development.



Geotechnologies, Inc.

439 Western Avenue, Glendale, California 91201-2837 • Tel: 818.240.9600 • Fax: 818.240.9675
www.geoteq.com

July 9, 2014
File No. 20784
Page 12

Utility Trench Backfill

Utility trenches should be backfilled with controlled fill. The utility should be bedded with clean sands at least one foot over the crown. The remainder of the backfill may be onsite soil compacted to 90 percent of the laboratory maximum density. Utility trench backfill should be tested by representatives of this firm in accordance with the most recent revision of ASTM D-1557.

Wet Soils

Pumping (yielding or vertical deflection) of the high-moisture content soils at the bottom of the excavation may occur during operation of heavy equipment. Where pumping is encountered, the exposed surface should be scarified at least 6 inches and allowed to dry to near the optimum moisture content, and then recompact to at least 90 percent of the maximum dry density.

Where excessive pumping is encountered, angular minimum ¾-inch gravel should be placed and worked into the subgrade. The exact thickness of the gravel would be a trial and error procedure, and would be determined in the field. It would likely be on the order of 1 to 2 feet thick. The gravel will help to densify the subgrade as well as function as a stabilization material upon which heavy equipment may operate.

It is not recommended that rubber tire construction equipment attempt to operate directly on the pumping subgrade soils prior to placing the gravel. Direct operation of rubber tire equipment on the soft subgrade soils will likely result in excessive disturbance to the soils, which in turn will result in a delay to the construction schedule since those soils disturbed during operation of heavy equipment would have to be removed and properly recompact.



Geotechnologies, Inc.
439 Western Avenue, Glendale, California 91201-2837 • Tel: 818.240.9600 • Fax: 818.240.9675
www.geoteq.com

July 9, 2014
File No. 20784
Page 13

Shrinkage

Shrinkage results when a volume of soil removed at one density is compacted to a higher density. A shrinkage factor between 5 and 15 percent should be anticipated when excavating and recompact the existing fill and underlying native geologic materials on the site to an average comparative compaction of 92 percent.

Weather Related Grading Considerations

When rain is forecast all fill that has been spread and awaits compaction shall be properly compacted prior to stopping work for the day or prior to stopping due to inclement weather. These fills, once compacted, shall have the surface sloped to drain to an area where water can be removed.

Temporary drainage devices should be installed to collect and transfer excess water to the street in non-erosive drainage devices. Drainage should not be allowed to pond anywhere on the site, and especially not against any foundation or retaining wall. Drainage should not be allowed to flow uncontrolled over any descending slope.

Work may start again, after a period of rainfall, once the site has been reviewed by a representative of this office. Any soils saturated by the rain shall be removed and aerated so that the moisture content will fall within three percent of the optimum moisture content.

Surface materials previously compacted before the rain shall be scarified, brought to the proper moisture content and recompact prior to placing additional fill, if considered necessary by a representative of this firm.



Geotechnologies, Inc.
439 Western Avenue, Glendale, California 91201-2837 • Tel: 818.240.9600 • Fax: 818.240.9675
www.geoteq.com

July 9, 2014
File No. 20784
Page 14

Abandoned Seepage Pits

No abandoned seepage pits were encountered during exploration and none are known to exist on the site. However, should such a structure be encountered during grading, options to permanently abandon seepage pits include complete removal and backfill of the excavation with compacted fill, or drilling out the loose materials and backfilling to within a few feet of grade with slurry, followed by a compacted fill cap.

If the subsurface structures are to be removed by grading, the entire structure should be demolished. The resulting void may be refilled with compacted soil. Concrete and brick generated during the seepage pit removal may be reused in the fill as long as all fragments are less than 6 inches in longest dimension and the debris comprises less than 15 percent of the fill by volume. All grading should comply with the recommendations of this report.

Where the seepage pit structure is to be left in place, the seepage pits should be cleaned of all soil and debris. This may be accomplished by drilling. The pits should be filled with minimum 1-1/2 sack concrete slurry to within 5 feet of the bottom of the proposed foundations. In order to provide a more uniform foundation condition, the remainder of the void should be filled with controlled fill.

Geotechnical Observations and Testing During Grading

Geotechnical observations and testing during grading are considered to be a continuation of the geotechnical investigation. It is critical that the geotechnical aspects of the project be reviewed by representatives of Geotechnologies, Inc. during the construction process. Compliance with the design concepts, specifications or recommendations during construction requires review by this firm during the course of construction. Any fill which is placed should be observed, tested, and



Geotechnologies, Inc.

439 Western Avenue, Glendale, California 91201-2837 • Tel: 818.240.9600 • Fax: 818.240.9675
www.geoteq.com

July 9, 2014
File No. 20784
Page 15

verified if used for engineered purposes. Please advise this office at least twenty-four hours prior to any required site visit.

LEED Considerations

The Leadership in Energy and Environmental Design (LEED) Green Building Rating System encourages adoption of sustainable green building and development practices. Credit for LEED Certification can be assigned for reuse of construction waste and diversion of materials from landfills in new construction.

In an effort to provide the design team with a viable option in this regard, demolition debris could be crushed onsite in order to use it in the ongoing grading operations. The environmental ramifications of this option, if any, should be considered by the team.

The demolition debris should be limited to concrete, asphalt and other non-deleterious materials. All deleterious materials should be removed including, but not limited to, paper, garbage, ceramic materials and wood.

For structural fill applications, the materials should be crushed to 2 inches in maximum dimension or smaller. The crushed materials should be thoroughly blended and mixed with onsite soils prior to placement as compacted fill. The amount of crushed material should not exceed 20 percent. The blended and mixed materials should be tested by this office prior to placement to insure it is suitable for compaction purposes. The blended and mixed materials should be tested by Geotechnologies, Inc. during placement to insure that it has been compacted in a suitable manner.



Geotechnologies, Inc.

439 Western Avenue, Glendale, California 91201-2837 • Tel: 818.240.9600 • Fax: 818.240.9675
www.geoteq.com

July 9, 2014
File No. 20784
Page 16

FOUNDATION DESIGN

Miscellaneous Conventional Foundations

Any proposed lightly-loaded uninhabitable structures may be supported by conventional foundations deepened through the existing fill in order to bear in the underlying alluvial soils.

Conventional foundations may bear in older alluvial soils found four feet below existing site grades. The alluvial soils consist of sandy silts. Foundations may be designed based on the 2013 California Building Code Table 1806. For sandy silt a bearing pressure of 1,500 pounds per square foot may be utilized. Foundations should be embedded a minimum of 1 foot into native soils.

Resistance to lateral loading may be provided by passive earth pressure at 100 pounds per square foot per foot of depth. Since the recommended bearing value is a net value, the weight of concrete in the foundations may be taken as 50 pounds per cubic foot and the weight of the soil backfill may be neglected when determining the downward load on the foundations. When combining passive and friction for lateral resistance, the passive component should be reduced by one third. A one-third increase in the passive value may be used for wind or seismic loads.

Where foundations require deepening to bear in competent native soils. The deepened portion of the foundation excavations may be filled with controlled low-strength material (CLSM). This is allowable under 2013 California Building Code section 1804.6.

The foundation excavations should be cleaned of all loose materials prior to placement of the CLSM. The CLSM should consist of 3-sack slurry mix. A sample of the CLSM should be collected and checked for compressive strength. The results of the tests should indicate that the CLSM at 28 days yields a minimum of 100 pounds per square inch. This value translates to over 14,000 pounds per square foot.



Geotechnologies, Inc.
439 Western Avenue, Glendale, California 91201-2837 • Tel: 818.240.9600 • Fax: 818.240.9675
www.geoteq.com

July 9, 2014
File No. 20784
Page 17

The foundation may be poured on top of the cured CLSM. Some method of ensuring a good bond between the top of the CLSM and the concrete of the proposed foundation should be employed.

The bearing capacities indicated above are for the total of dead and frequently applied live loads, and may be increased by one third for short duration loading, which includes the effects of wind or seismic forces.

Foundation Reinforcement

All continuous foundations should be reinforced with a minimum of four #4 steel bars. Two should be placed near the top of the foundation, and two should be placed near the bottom.

Lateral Design

Passive geologic pressure for the sides of foundations poured against undisturbed alluvium soil may be computed as an equivalent fluid having a density of 100 pounds per cubic foot with a maximum earth pressure of 1,500 pounds per square foot.

When combining passive and friction for lateral resistance, the passive component should be reduced by one third. A one-third increase in the passive value may be used for wind or seismic loads.



Geotechnologies, Inc.
439 Western Avenue, Glendale, California 91201-2837 • Tel: 818.240.9600 • Fax: 818.240.9675
www.geoteq.com

July 9, 2014
File No. 20784
Page 18

Foundation Settlement

Settlement of the foundation system is expected to occur on initial application of loading. The maximum settlement is expected to be ½-inch and occur below the heaviest loaded columns. Differential settlement is not expected to exceed ¼-inch.

Foundation Observations

It is critical that all foundation excavations are observed by a representative of this firm to verify penetration into the recommended bearing materials. The observation should be performed prior to the placement of reinforcement. Foundations should be deepened to extend into satisfactory geologic materials, if necessary.

Foundation excavations should be cleaned of all loose soils prior to placing steel and concrete. Any required foundation backfill should be mechanically compacted, flooding is not permitted.

TEMPORARY EXCAVATIONS

Excavations up to 5 feet in height may be anticipated in order for the foundations to bear in alluvial soils. The excavations are expected to expose dense native soils, which are suitable for vertical excavations up to 5 feet where not surcharged by adjacent traffic or structures.

Where sufficient space is available, temporary unsurcharged embankments could be cut at a uniform 1:1 (h:v) slope gradient in their entirety, up to a maximum height of 8 feet. A uniform sloped excavation does not have a vertical component. Sloped excavations with vertical cuts at the toe of the slope are not recommended.



Geotechnologies, Inc.
439 Western Avenue, Glendale, California 91201-2837 • Tel: 818.240.9600 • Fax: 818.240.9675
www.geoteq.com

July 9, 2014
File No. 20784
Page 19

Where sloped embankments are utilized, the tops of the slopes should be barricaded to prevent vehicles and storage loads near the top of slope within a horizontal distance equal to the depth of the excavation. If the temporary construction embankments are to be maintained during the rainy season, berms are strongly recommended along the tops of the slopes to prevent runoff water from entering the excavation and eroding the slope faces. Water should not be allowed to pond on top of the excavation nor to flow towards it.

Excavation Observations

It is critical that the soils exposed in the cut slopes are observed by a representative of Geotechnologies, Inc. during excavation so that modifications of the slopes can be made if variations in the geologic material conditions occur. Many building officials require that temporary excavations should be made during the continuous observations of the geotechnical engineer. All excavations should be stabilized within 30 days of initial excavation.

SLABS ON GRADE

Concrete Slabs-on Grade

Outdoor concrete flatwork should be a minimum of 4 inches in thickness. Outdoor concrete flatwork should be cast over undisturbed alluvial soils or properly compacted fill materials. Any geologic materials loosened or over-excavated should be wasted from the site or properly compacted to 90 percent of the maximum dry density.



Geotechnologies, Inc.
439 Western Avenue, Glendale, California 91201-2837 • Tel: 818.240.9600 • Fax: 818.240.9675
www.geoteq.com

July 9, 2014
 File No. 20784
 Page 20

Concrete Crack Control

The recommendations presented in this report are intended to reduce the potential for cracking of concrete slabs-on-grade due to settlement. However even where these recommendations have been implemented, foundations, stucco walls and concrete slabs-on-grade may display some cracking due to minor soil movement and/or concrete shrinkage. The occurrence of concrete cracking may be reduced and/or controlled by limiting the slump of the concrete used, proper concrete placement and curing, and by placement of crack control joints at reasonable intervals, in particular, where re-entrant slab corners occur.

For standard control of concrete cracking, a maximum crack control joint spacing of 12 feet should not be exceeded. Lesser spacing's would provide greater crack control. Joints at curves and angle points are recommended. The crack control joints should be installed as soon as practical following concrete placement. Crack control joints should extend a minimum depth of one-fourth the slab thickness. Construction joints should be designed by a structural engineer.

Complete removal of the existing fill soils beneath outdoor flatwork such as walkways or patio areas, is not required, however, due to the rigid nature of concrete, some cracking, a shorter design life and increased maintenance costs should be anticipated. In order to provide uniform support beneath the flatwork it is recommended that a minimum of 12 inches of the exposed subgrade beneath the flatwork be scarified and recompact to 90 percent relative compaction.

Slab Reinforcing

Outdoor flatwork should be reinforced with a minimum of #3 steel bars on 18-inch centers each way.



Geotechnologies, Inc.
 439 Western Avenue, Glendale, California 91201-2837 • Tel: 818.240.9600 • Fax: 818.240.9675
 www.geoteq.com

July 9, 2014
 File No. 20784
 Page 21

PAVEMENTS

Prior to placing paving, the existing grade should be scarified to a depth of 12 inches, moistened as required to obtain optimum moisture content, and recompact to 90 percent of the maximum density as determined by the most recent revision of ASTM D 1557. The client should be aware that removal of all existing fill in the area of new paving is not required. However, pavement constructed in this manner will most likely have a shorter design life and increased maintenance costs. The following pavement sections are recommended for use within the subject property:

Service	Asphalt Pavement Thickness Inches	Base Course Inches
Passenger Cars (TI=4)	3	6
Moderate Truck (TI=6)	4	10

Aggregate base should be compacted to a minimum of 95 percent of the most recent revision of ASTM D 1557 laboratory maximum dry density. Base materials should conform with Sections 200-2.2 or 200-2.4 of the "Standard Specifications for Public Works Construction", (Green Book), 1991 Edition.

Concrete paving may be used on the project. Based on the highway design manual, for a Traffic Index of up to 6, concrete paving should be 6 inches of concrete over 4 inches of compacted base.

The occurrence of concrete cracking may be reduced and/or controlled by limiting the slump of the concrete used, proper concrete placement and curing, and by placement of crack control joints at reasonable intervals, in particular, where re-entrant slab corners occur.

For standard control of concrete cracking, a maximum crack control joint spacing of 12 feet should not be exceeded. Lesser spacings would provide greater crack control. Joints at curves and angle points are recommended. The crack control joints should be installed as soon as practical



Geotechnologies, Inc.
 439 Western Avenue, Glendale, California 91201-2837 • Tel: 818.240.9600 • Fax: 818.240.9675
 www.geoteq.com

July 9, 2014
File No. 20784
Page 22

following concrete placement. Crack control joints should extend a minimum depth of one-fourth the slab thickness. Construction joints should be designed by a structural engineer. Concrete paving should be reinforced with a minimum of #3 steel bars on 18-inch centers each way.

The performance of pavement is highly dependent upon providing positive surface drainage away from the edges. Ponding of water on or adjacent to pavement can result in saturation of the subgrade materials and subsequent pavement distress. If planter islands are planned, the perimeter curb should extend a minimum of 12 inches below the bottom of the aggregate base.

The management of pavement wear primarily is focused on the distress caused by vertical loads. The reduction of vertical loading from large vehicles is assisted by increasing the number of axles. Multi-axle groups reduce the peak vertical loading and, when closely spaced, reduce the magnitude of the strain cycles to which the pavement is subjected. However, where tight low-speed turns are executed, non-steering axle groups lead to transverse shear forces (scuffing) at the pavement-tire interface.

With asphaltic concrete pavements, tensile shear stresses from tires can cause surface cracking and raveling. Thus the increased use of non-steering axle groups results in increased pavement wear in the vicinity of intersections and turnarounds where tight low speed turns are executed.

When designing intersections and turnarounds, the turn radius should be as large as possible. This will lead to reduced “scuffing” forces. Where tight radius turns are unavoidable, the pavement surface design should take into account the high level of “scuffing” forces that will occur and thickened pavement and subgrade and base course keyways should be considered to assist in the reduction of lateral deflection.



Geotechnologies, Inc.

439 Western Avenue, Glendale, California 91201-2837 • Tel: 818.240.9600 • Fax: 818.240.9675
www.geoteq.com

July 9, 2014
File No. 20784
Page 23

SITE DRAINAGE

Proper surface drainage is critical to the future performance of the project. Saturation of a soil can cause it to lose internal shear strength and increase its compressibility, resulting in a change in the designed engineering properties. Proper site drainage should be maintained at all times.

All site drainage, with the exception of any required to be disposed of onsite by stormwater regulations, should be collected and transferred to the street in non-erosive drainage devices. Drainage should not be allowed to pond anywhere on the site, and especially not against any foundation or retaining wall. Drainage should not be allowed to flow uncontrolled over any descending slope. Planters which are located within a distance equal to the depth of a retaining wall should be sealed to prevent moisture adversely affecting the wall. Planters which are located within five feet of a foundation should be sealed to prevent moisture effecting the earth materials supporting the foundation.

STORMWATER DISPOSAL

Introduction

Recently regulatory agencies have been requiring the disposal of a certain amount of stormwater generated on a site by infiltration into the site soils. Increasing the moisture content of a soil can cause it to lose internal shear strength and increase its compressibility, resulting in a change in the designed engineering properties. This means that any overlying structure, including buildings, pavements and concrete flatwork, could sustain damage due to saturation of the subgrade soils. Structures serviced by subterranean levels could be adversely impacted by stormwater disposal by increasing the design fluid pressures on retaining walls and causing leaks in the walls. Proper site drainage is critical to the performance of any structure in the built environment.



Geotechnologies, Inc.

439 Western Avenue, Glendale, California 91201-2837 • Tel: 818.240.9600 • Fax: 818.240.9675
www.geoteq.com

July 9, 2014
File No. 20784
Page 24

Percolation Testing

In order to establish a percolation rate for the site soils, the exploratory excavation was used for a percolation test. The test pit was presoaked for a minimum of 4 hours prior to the test. After the presoak, the test pit was refilled with water and the absorption of the soils was measured.

Based on results of the percolation tests, a percolation rate of 0.4 inches per hour was established. This rate is based on the alluvial soils encountered in the test pit at a depth of 5 feet. It is recommended that stormwater should only percolate into natural alluvial soils. It should be noted that the recommended percolation rate is based on testing at a discrete location and the overall percolation rate of the system could vary considerably.

The Proposed System

The locations for potential stormwater disposal have not been specifically addressed on this site. It is the opinion of this office that stormwater infiltration is possible on this site, however when the plan achieves more definition, this office should address the potential impacts.

The infiltration device will most likely be situated within below flatwork or paving. The client and design team must be aware that repeatedly saturation of the soils will cause settlement to occur. The settlement will manifest itself as cracking in the pavement, flatwork and other improvements. These improvements will require increased maintenance and have a shorter design life.



Geotechnologies, Inc.
439 Western Avenue, Glendale, California 91201-2837 • Tel: 818.240.9600 • Fax: 818.240.9675
www.geoteq.com

July 9, 2014
File No. 20784
Page 25

Recommendations

The design and construction of stormwater infiltration facilities is not the responsibility of the geotechnical engineer. However, based on the experience of this firm, it is recommended that several aspects of the use of such facilities should be considered by the design and construction team:

- Open infiltration basins have many negative associated issues. Such a design must consider attractive nuisance, impacts to growing vegetation, impacts to air quality and vector control.
- All infiltration devices should be provided with overflow protection. Once the device is full of water, additional water flowing to the device should be diverted to another acceptable disposal area, or disposed offsite in an acceptable manner.
- All connections associated with stormwater infiltration devices should be sealed and water-tight. Water leaking into the subgrade soils can lead to loss of strength, piping, erosion, settlement and/or expansion of the effected earth materials.
- Excavations proposed for the installation of stormwater facilities should comply with the "Temporary Excavations" sections of this (the referenced) reports well as CalOSHA Regulations where applicable.

DESIGN REVIEW

Engineering of the proposed project should not begin until approval of the geotechnical report by the Building Official is obtained in writing. Significant changes in the geotechnical recommendations may result during the building department review process.

It is recommended that the geotechnical aspects of the project be reviewed by this firm during the design process. This review provides assistance to the design team by providing specific



Geotechnologies, Inc.
439 Western Avenue, Glendale, California 91201-2837 • Tel: 818.240.9600 • Fax: 818.240.9675
www.geoteq.com

July 9, 2014
File No. 20784
Page 26

recommendations for particular cases, as well as review of the proposed construction to evaluate whether the intent of the recommendations presented herein are satisfied.

CONSTRUCTION MONITORING

Geotechnical observations and testing during construction are considered to be a continuation of the geotechnical investigation. It is critical that this firm review the geotechnical aspects of the project during the construction process. Compliance with the design concepts, specifications or recommendations during construction requires review by this firm during the course of construction. All foundations should be observed by a representative of this firm prior to placing concrete or steel. Any fill which is placed should be observed, tested, and verified if used for engineered purposes. Please advise Geotechnologies, Inc. at least twenty-four hours prior to any required site visit.

If conditions encountered during construction appear to differ from those disclosed herein, notify Geotechnologies, Inc. immediately so the need for modifications may be considered in a timely manner.

It is the responsibility of the contractor to ensure that all excavations and trenches are properly sloped or shored. All temporary excavations should be cut and maintained in accordance with applicable OSHA rules and regulations.

EXCAVATION CHARACTERISTICS

The exploration performed for this investigation is limited to the geotechnical excavations described. Direct exploration of the entire site would not be economically feasible. The owner, design team and contractor must understand that differing excavation and drilling conditions may



Geotechnologies, Inc.

439 Western Avenue, Glendale, California 91201-2837 • Tel: 818.240.9600 • Fax: 818.240.9675
www.geoteq.com

July 9, 2014
File No. 20784
Page 27

be encountered based on boulders, gravel, oversize materials, groundwater and many other conditions. Fill materials, especially when they were placed without benefit of modern grading codes, regularly contain materials which could impede efficient grading and drilling. The contractor should be familiar with the site and the geologic materials in the vicinity.

CLOSURE AND LIMITATIONS

The purpose of this report is to aid in the design and completion of the described project. Implementation of the advice presented in this report is intended to reduce certain risks associated with construction projects. The professional opinions and geotechnical advice contained in this report are sought because of special skill in engineering and geology and were prepared in accordance with generally accepted geotechnical engineering practice. Geotechnologies, Inc. has a duty to exercise the ordinary skill and competence of members of the engineering profession. Those who hire Geotechnologies, Inc. are not justified in expecting infallibility, but can expect reasonable professional care and competence.

The scope of the geotechnical services provided did not include any environmental site assessment for the presence or absence of organic substances, hazardous/toxic materials in the soil, surface water, groundwater, or atmosphere, or the presence of wetlands.

Proper compaction is necessary to reduce settlement of overlying improvements. Some settlement of compacted fill should be anticipated. Any utilities supported therein should be designed to accept differential settlement.

If corrosion sensitive improvements are planned, it is recommended that a comprehensive corrosion study should be commissioned. The study will develop recommendations to avoid premature corrosion of buried pipes and concrete structures in direct contact with the soils.



Geotechnologies, Inc.

439 Western Avenue, Glendale, California 91201-2837 • Tel: 818.240.9600 • Fax: 818.240.9675
www.geoteq.com

July 9, 2014
File No. 20784
Page 28

GEOTECHNICAL TESTING

Classification and Sampling

The soil is continuously logged by a representative of this firm and classified by visual examination in accordance with the Unified Soil Classification system. The field classification is verified in the laboratory, also in accordance with the Unified Soil Classification System. Laboratory classification may include visual examination, Atterberg Limit Tests and grain size distribution. The final classification is shown on the excavation logs.

Samples of the geologic materials encountered in the exploratory excavations were collected and transported to the laboratory. Undisturbed samples of soil are obtained at frequent intervals. Unless noted on the excavation logs as an SPT sample, samples acquired while utilizing a hollow-stem auger drill rig are obtained by driving a thin-walled, California Modified Sampler with successive 30-inch drops of a 140-pound hammer. Samples from bucket-auger drilling are obtained utilizing a California Modified Sampler with successive 12-inch drops of a Kelly bar, whose weight is noted on the excavation logs. The soil is retained in brass rings of 2.50 inches outside diameter and 1.00 inch in height. The central portion of the samples are stored in close fitting, waterproof containers for transportation to the laboratory. Samples noted on the excavation logs as SPT samples are obtained in accordance with the most recent revision of ASTM D 1586. Samples are retained for 30 days after the date of the geotechnical report.

Expansion Index Testing

The expansion tests performed on the remolded samples are in accordance with the Expansion Index testing procedures, as described in the most recent revision of ASTM D4829. The soil sample is compacted into a metal ring at a saturation degree of 50 percent. The ring sample is then



Geotechnologies, Inc.
439 Western Avenue, Glendale, California 91201-2837 • Tel: 818.240.9600 • Fax: 818.240.9675
www.geoteq.com

July 9, 2014
File No. 20784
Page 29

placed in a consolidometer, under a vertical confining pressure of 1 lbf/square inch and inundated with distilled water. The deformation of the specimen is recorded for a period of 24 hours or until the rate of deformation becomes less than 0.0002 inches/hour, whichever occurs first. The expansion index, EI, is determined by dividing the difference between final and initial height of the ring sample by the initial height, and multiplied by 1,000. Results are presented in Plate D of this report.

Laboratory Compaction Characteristics

The maximum dry unit weight and optimum moisture content of a soil are determined by use of the most recent revision of ASTM D 1557. A soil at a selected moisture content is placed in five layers into a mold of given dimensions, with each layer compacted by 25 blows of a 10 pound hammer dropped from a distance of 18 inches subjecting the soil to a total compactive effort of about 56,000 pounds per cubic foot. The resulting dry unit weight is determined. The procedure is repeated for a sufficient number of moisture contents to establish a relationship between the dry unit weight and the water content of the soil. The data when plotted represent a curvilinear relationship known as the compaction curve. The values of optimum moisture content and modified maximum dry unit weight are determined from the compaction curve. Results are presented in Plate D of this report.



Geotechnologies, Inc.
439 Western Avenue, Glendale, California 91201-2837 • Tel: 818.240.9600 • Fax: 818.240.9675
www.geoteq.com

REFERENCES

- Applied Technology Council (1978), Tentative Provisions for Development of Seismic Regulations for Buildings: ATC Publication ATC 3-06, NBS Special Publication 510, NSF Publication 78-8.
- Boore, D.M., Joyner, W.B., and Fumal, T.E. (1993), Estimation of Response Spectra and Peak Accelerations From Western North American Earthquakes: An interim Report, U.S. Geological Survey Open-File Report 93-509, 15 pp.
- California Department of Conservation, Division of Mines and Geology, 1998, Seismic Hazard Zone Report of the Beverly Hills 7½-Minute Quadrangle, Los Angeles County, California, C.D.M.G. Seismic Hazard Zone Report 023, Map scale 1:24,000.
- California Department of Conservation, Division of Mines and Geology, 1999, Seismic Hazard Zones Map, Beverly Hills 7½-minute Quadrangle.
- California Geological Survey, 2008, Guidelines for Evaluation and Mitigation of Seismic Hazards in California, Special Publication 117A.
- Hauksson, E. (1992), Seismicity, Faults, and Earthquake Potential in Los Angeles, Southern California: Engineering Geology Practice in Southern California, Special Publication No. 4, Association of Engineering Geologists.
- Jennings, Charles W. (1994), Fault Activity Map of California and Adjacent Areas, California Division of Mines and Geology.
- Leighton and Associates, Inc. (1990), Technical Appendix to the Safety Element of the Los Angeles County General Plan: Hazard Reduction in Los Angeles County.
- Martin, G.R., and Lew, M., 1999, Co-chairs and Editors of the Implementation Committee, "Recommended Procedures for Implementation of DMG Special Publication 117, Guidelines for Analyzing and Mitigating Liquefaction Hazards in California," Organized through the Southern California Earthquake Center, University of Southern California.



Geotechnologies, Inc.

439 Western Avenue, Glendale, California 91201-2837 • Tel: 818.240.9600 • Fax: 818.240.9675
www.geoteq.com

REFERENCES - continued

- O'Rourke, T.D., Pease, J.W. (1997), Mapping Liquefiable Layer Thickness for Seismic Hazard Assessment, Journal of the Geotechnical Engineering Division, American Society of Civil Engineers, vol. 123, no. 1, pp. 46-56.
- Seed, H.B. , Idriss, I.M., and Arango, I. (1983), Evaluation of Liquefaction Potential Using Field Performance Data, Journal of the Geotechnical Engineering Division, American Society of Civil Engineers, vol. 109, no. 3, pp. 458-482.
- Tokimatsu, K., and Yoshimi, Y. (1983), Empirical Correlation of Soil Liquefaction Based on SPT N-Value and Fines Content, Soils and Foundations, Japanese Society of Soil Mechanics and Foundation Engineering, vol. 23, no. 4, pp. 56-74.
- United States Geological Survey, 2008, U.S.G.S. Interactive Deaggregation Program. <http://eqint.cr.usgs.gov/deaggint/2008/index.php>.
- United States Geological Survey, 2011, U.S.G.S. Ground Motion Parameter Calculator (Version 5.1.0). <http://earthquake.usgs.gov/research/hazmaps/design/>.
- Yerkes, R.F., McCulloh, T.H., Schoellhamer, J.E., Vedder, J.G., Geology of the Los Angeles Basin, Southern California- An Introduction, U.S. Geological Professional Paper 420-A.
- Youd, T. L. and Garris, C. T., 1995, Liquefaction-Induced Ground Surface Disruption, Journal of Geotechnical Engineering, ASCE, Vol. 121, No. 11, P. 805-809.



Geotechnologies, Inc.

439 Western Avenue, Glendale, California 91201-2837 • Tel: 818.240.9600 • Fax: 818.240.9675
www.geoteq.com

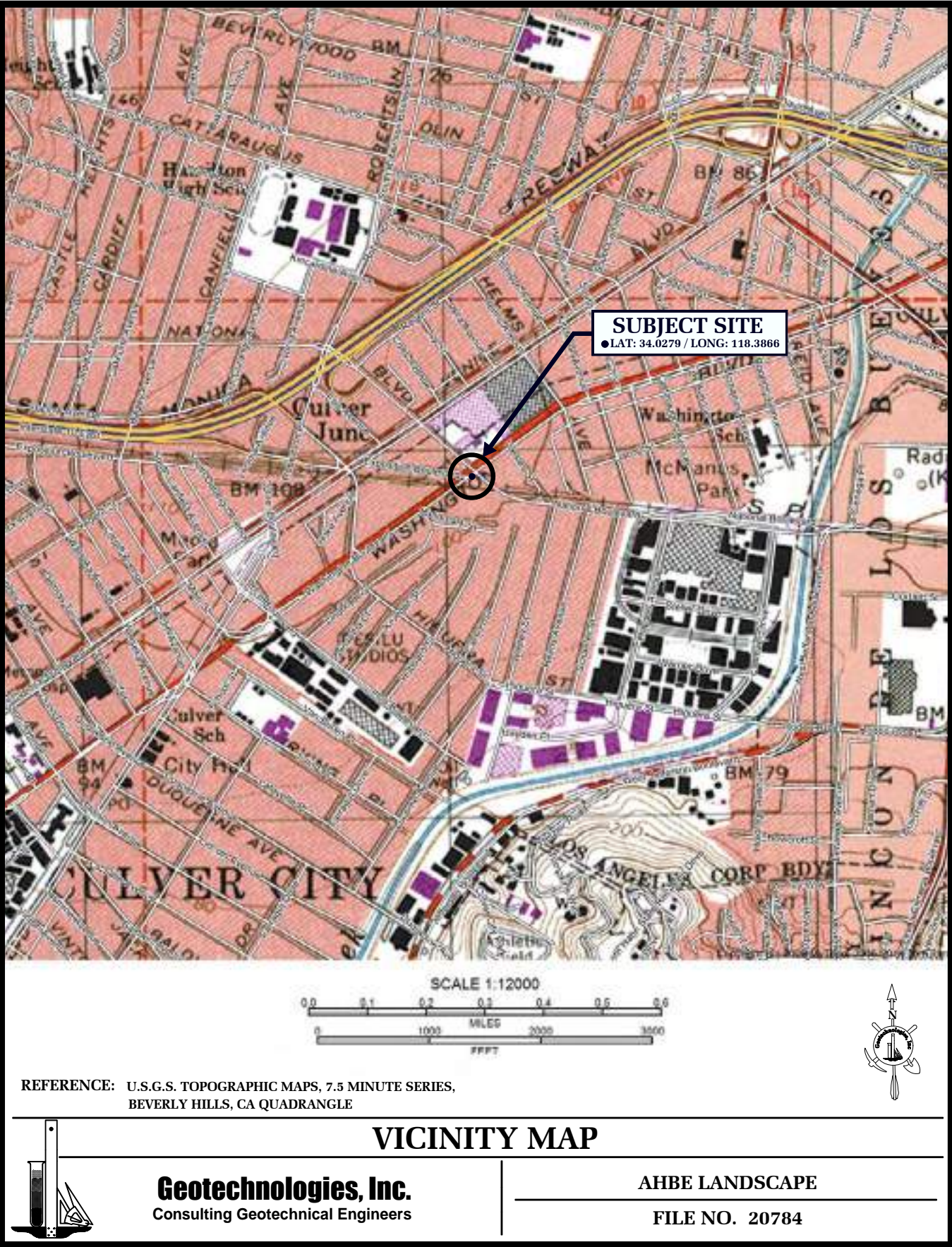

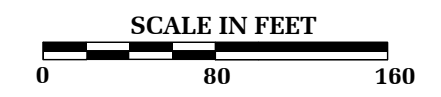
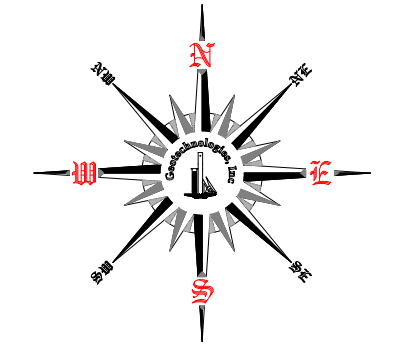

LEGEND

TP1  LOCATION & NUMBER OF TEST PIT

REFERENCE: TRACT SITE AREA BY THE CITY OF LOS ANGELES
AUGUST 14, 2013

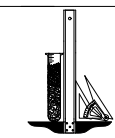

Geotechnologies, Inc.
Consulting Geotechnical Engineers

PLOT PLAN

AHBE LANDSCAPE

File No.: 20784

Date: June '14

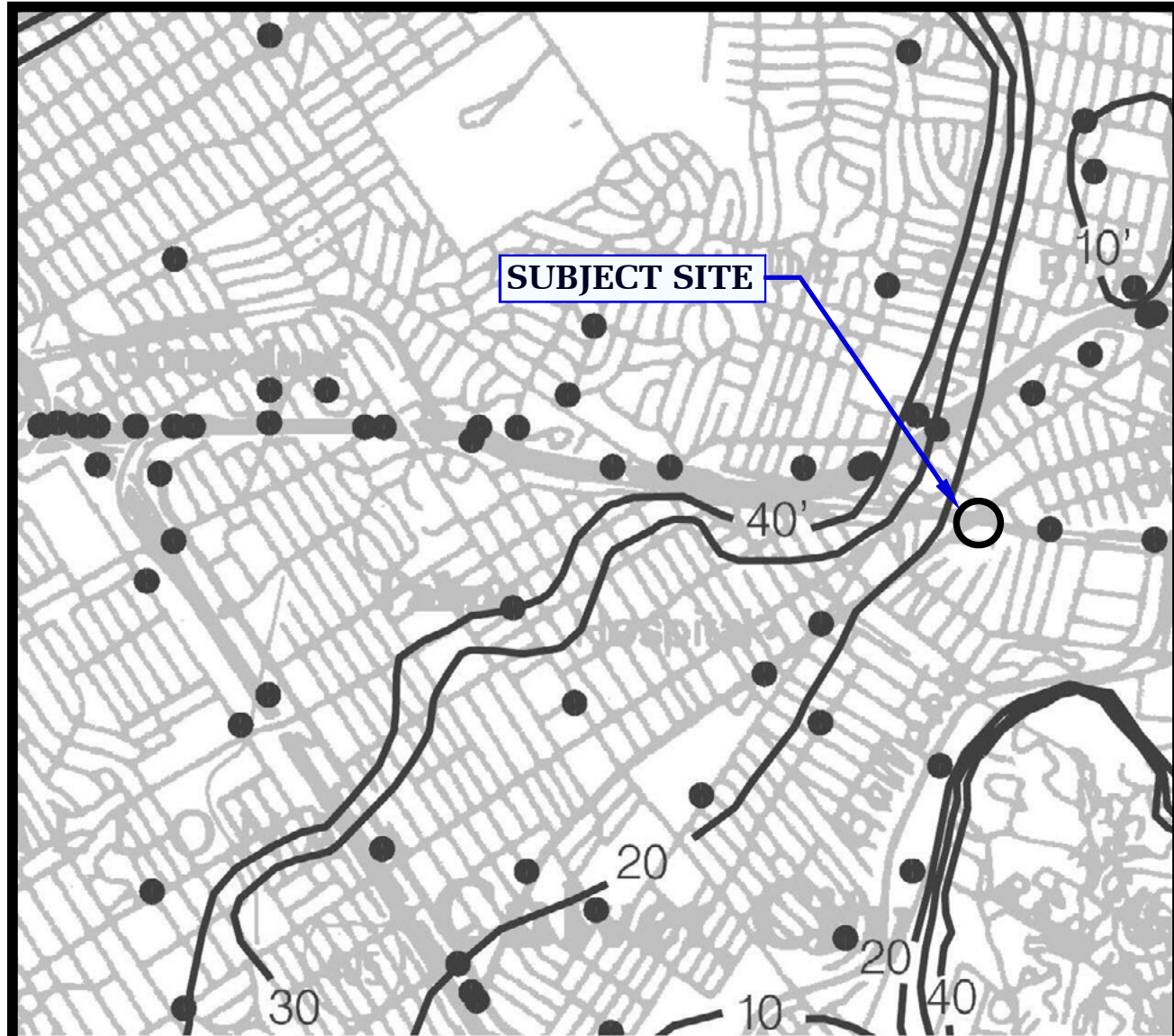

ONE MILE
SCALE

20' Depth to groundwater in feet

REFERENCE: CDMG, SEISMIC HAZARD ZONE REPORT, 023
BEVERLY HILLS 7.5 - MINUTE QUADRANGLE, LOS ANGELES COUNTY, CALIFORNIA (1998, REVISED 2005)



HISTORICALLY HIGHEST GROUNDWATER LEVELS

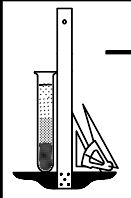

Geotechnologies, Inc.
Consulting Geotechnical Engineers

AHBE LANDSCAPE

FILE No. 20784

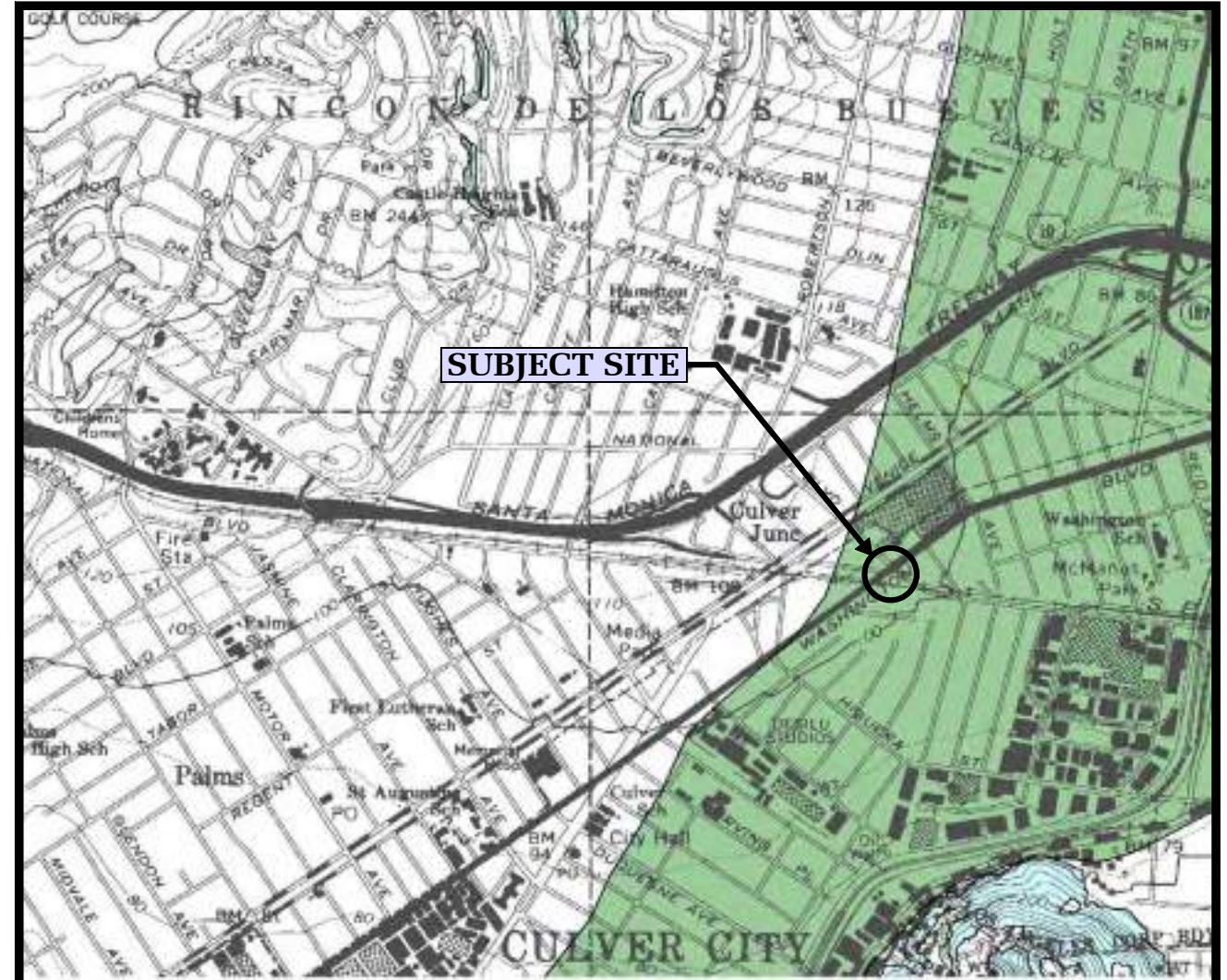

SCALE 1:24,000

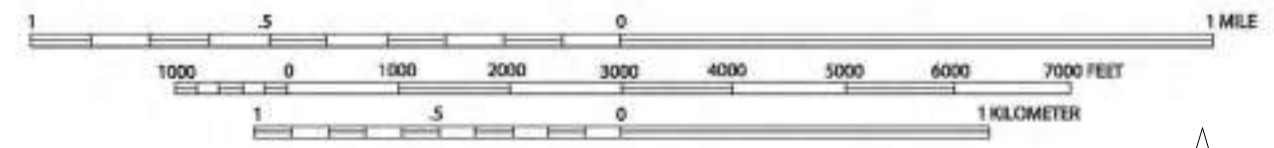

LIQUEFACTION AREA

REFERENCE: SEISMIC HAZARD ZONES, BEVERLY HILLS QUADRANGLE OFFICIAL MAP (CDMG, 1999)



SEISMIC HAZARD ZONE MAP

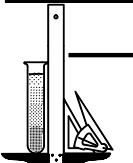

Geotechnologies, Inc.
Consulting Geotechnical Engineers

AHBE LANDSCAPE

FILE NO. 20784

LOG OF TEST PIT NUMBER 1

AHBE Landscape

Drilling Date: 06/13/14

File No. 20784

Method: Hand Dug Hand Auger

Sample Depth ft.	Moisture Content %	Dry Density p.c.f.	Depth in feet	USCS Class.	Description
			0 --		Surface Conditions: Lawn Area
			-		FILL: Silty Sand to Sand, dark to yellowish brown, moist, medium dense, fine grained
			1 --		
			-		
			2 --		Silty Sand to Sandy Silt, dark and grayish brown, Stiff, fine grained
			-		
			3 --		Sandy Silt, dark and yellowish brown
			-		
			4 --	ML	Sandy Silt, dark brown, moist, stiff
			-		
			5 --		Sandy to Clayey Silt
			-		
			6 --		Total Depth 6 feet
			-		No Water
			7 --		Fill to 4 feet
			-		
			8 --		
			-		
			9 --		NOTE: The stratification lines represent the approximate boundary between earth types; the transition may be gradual.
			-		
			10 --		Used 4-inch diameter Hand-Augering Equipment; Hand Sampler
			-		
			11 --		
			-		
			12 --		
			-		
			13 --		
			-		
			14 --		
			-		
			15 --		
			-		
			16 --		
			-		
			17 --		
			-		
			18 --		
			-		
			19 --		
			-		
			20 --		
			-		
			21 --		
			-		
			22 --		
			-		
			23 --		
			-		
			24 --		
			-		
			25 --		
			-		

GEOTECHNOLOGIES, INC.

Plate A-1

ASTM D-1557

SAMPLE	TP1 @ 1- 5'
SOIL TYPE:	SM/ML
MAXIMUM DENSITY pcf.	122.1
OPTIMUM MOISTURE %	10.5

ASTM D 4829

SAMPLE	TP1 @ 1- 5'
SOIL TYPE:	SM/ML
EXPANSION INDEX UBC STANDARD 18-2	50
EXPANSION CHARACTER	<u>MODERATE</u>

SULFATE CONTENT

SAMPLE	TP1 @ 1-5'
SULFATE CONTENT: (percentage by weight)	< 0.10 %

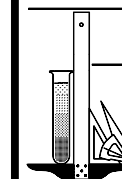

COMPACTION/EXPANSION/SULFATE DATA SHEET

Geotechnologies, Inc.
Consulting Geotechnical Engineers

AHBE LANDSCAPE

FILE NO. 20784

PLATE: D



1100 Corporate Center Dr., Suite 201
 Monterey Park, CA 91754
 t: 323-260-4703 f: 323-260-4705
 www.koacorporation.com

MEMORANDUM

Date: July 2, 2014
To: Evan Mather, ASLA, RLA – AHBE
From: Stephen Bise, P.E.
Subject: Existing Conditions Assessment and Opportunities - Culver City TOD
 KOA Project JB31207

This document summarizes the engineering assessment and recommendations by KOA for possible enhancements throughout the Transit Oriented Development District (TOD) in Culver City. We have summarized below our observations of infrastructure deficiencies and opportunities for improvements. See the attached exhibits for reference.

AMERICANS WITH DISABILITIES ACT (ADA) – COMPLIANCE FOR ACCESSIBLE PEDESTRIAN PATH & SIGNALS

ADA guidelines require a clear path of travel 4 feet wide for pedestrians. Deficiencies with sidewalks, curb ramps, and driveways are described in the corresponding sections below.

The majority of sidewalks in the district meet ADA requirements with the exception of one location. On the southwest corner of Washington Boulevard and National Boulevard, there is a 3 foot pinch point between the existing traffic signal pole and controller cabinet. It is recommended to relocate the signal controller cabinet to the back of sidewalk to allow the required room for pedestrian travel.

Accessible Pedestrian Signals (APS) are not present at any intersection within the TOD. The intersections of Venice Boulevard at Robertson Boulevard and Venice Boulevard at National Boulevard are proposed to be modified/upgraded with APS as part of the Expo Metro Light Rail Project. It is recommended APS push buttons be installed at the following intersections.

- Washington Boulevard and Robertson Boulevard
- Washington Boulevard and Landmark Street
- Washington Boulevard and National Boulevard
- Washington Boulevard and Wesley Street (future signal)

APS push buttons include features of a vibrotactile surface and locator tones.

DRIVEWAYS

All driveways were assessed for compliance with the current Standard Plan for Public Works Construction (SPPWC). There are three driveways that provide only a 3 foot pedestrian path. This does not meet current ADA or SPPWC requirements and these should be reconstructed per current standards.



Due to the higher than standard curb height in the area, there are two driveways with steep slopes (<16%) which result in cars “bottoming out” at the top of the driveway. The steep slope is not in compliance with SPPWC and these driveways should be reconstructed to have a max slope of 12% where applicable.

There are six driveways that do not provide an ADA acceptable pedestrian path and these should be reconstructed to meet current standards.

All driveways are to be reconstructed along Wesley Street due to road widening in conjunction with the construction of the mixed-use development at 8770 Washington Boulevard. All reconstructed driveways should meet current ADA and SPPWC requirements.

SIDEWALKS & CURB RAMPS

There are several locations where the sidewalk is cracked and/or damaged from current construction in the area. All damaged sidewalk should be replaced to provide a clear and unobstructed path of travel for pedestrians. All new sidewalk shall have a maximum of 2 percent cross-slope and comply with the SPPWC. See the attached exhibits for recommended locations for sidewalk reconstruction.

There are several areas where a parking meters were removed, but the post remains. It is recommended that all remaining, un-used parking meter posts be removed and the adjoining sidewalk be repaired/replaced.

There is an existing parking lot on the south side of National Boulevard that is directly adjacent to the back of the sidewalk. It was observed that several parked cars encroach into the sidewalk area, which is a safety concern for pedestrians. It is recommended that a safety fence be installed at the back of the sidewalk due to the proximity of the parking stalls to the sidewalk.

All sidewalk is to be reconstructed along Wesley Street due to road widening in conjunction with the construction of the mixed-use development at 8770 Washington Boulevard. All reconstructed sidewalks shall meet current ADA and SPPWC requirements.

The curb ramps on the northeast and northwest corners of Washington Boulevard and National Boulevard do not meet ADA requirements and should be reconstructed per current SPPWC standards.

Curb ramps along Venice Boulevard at Robertson Boulevard, Exposition Boulevard, and National Boulevard are to be reconstructed as part of the Exposition Metro Light Rail Project.

STORM DRAINS

There are fifteen existing catch basins within the TOD. Three are proposed to be reconstructed/relocated in conjunction with developments currently under construction. The grate inlet catch basin on the north side of Washington Boulevard at Landmark Street is damaged and should be relocated and reconstructed to be a curb opening catch basin.

A City approved catch basin screen and/or debris collector, a best management practice (BMP), should be installed in all existing and reconstructed catch basins in the TOD. There are currently three catch basins with an existing BMP screen.



TREE WELLS

There are several vacant tree wells within the TOD that can be utilized with landscaping or a Low-Impact Development (LID) (See below section for LID recommendations). It was observed that there are a variety of tree well covers; bricks, metal grates, no cover, etc.

LIGHTING

There is consistent street lighting throughout the TOD. Street lighting on the south side of Venice Boulevard currently is temporary due to construction in the median.

A lack of lighting was observed at the bus stop under the Expo Line Bridge on the north side of Washington Boulevard. It is recommended additional lighting be installed at this location.

Pedestrian lighting in high pedestrian traffic areas is also recommended to improve safety and aesthetics.

BUS PULLOVERS

There are two opportunities for bus pullovers within the TOD. These locations have sufficient room within the public right-of-way and would improve traffic flow while a bus is stopped.

- Washington Boulevard, between Landmark Street and National Boulevard.
- Venice Boulevard, just east of Exposition Boulevard.

See the attached exhibit for illustrations.

There is currently no bus pad at the stop on National Boulevard, just west of Venice Boulevard. It is recommended that a bus pad be constructed per current SPPWC.

CROSSWALKS

Crosswalks at Washington Boulevard at Robertson Boulevard and Washington Boulevard at Nation Boulevard have been recently upgraded to continental style crosswalks.

Crosswalks at the following intersection should be upgraded to continental stripping or decorative pavers.

- Washington Boulevard and Landmark Street
- Washington Boulevard and Wesley Street (future signal)
- Venice Boulevard and Robertson Boulevard
- Venice Boulevard and National Boulevard



TRAFFIC DEMANDS FOR TURNING MOVEMENTS AT INTERSECTIONS

A traffic study conducted for the mixed-use development at 8770 Washington Boulevard contains mitigation measures to install a right turn lane for northbound traffic on National Boulevard onto Washington Boulevard. See the attached exhibit for illustration.

OPPORTUNITIES FOR BULB-OUTS & MEDIANS

There is an opportunity for a bulb-out at the southeast corner of Washington Boulevard and National Boulevard. The bulb-out could extend around the corner and down Washington Boulevard for approximately 100 feet. This would remove potential on-street parking at this location. However, it would also provide additional opportunities for landscaping or street furniture. See the attached exhibit for conceptual layout.

OPPORTUNITIES FOR LOW IMPACT DEVELOPMENT (LID)

There are several opportunities to incorporate LID's within the TOD. Due to the porosity of the native soil and previous LID history within the City of Culver City, it is recommended LID's be limited to bio-retention filtration systems/tree wells and be installed near catch basin. This will provide opportunity for a drainage outlet connection into the existing storm drain system. See the attached exhibits for recommended locations.

There is also an opportunity to install permeable pavers on the west side of Wesley Street. The traffic study for the adjacent mixed-used development recommended a loading/unloading zone north of the future driveway and loading dock. Permeable pavers could be installed to distinguish the loading boundaries while incorporating an LID. An outlet drain (if necessary) could be connected to the existing catch basin on Wesley Street. See the attached exhibits for illustration.

EXISTING CONDITIONS ASSESSMENT



EXISTING PORK-CHOP ISLAND. OPPORTUNITY FOR LANDSCAPING.



REMOVE AND REPLACE DAMAGED CURB AND CUTTER.



ADDRESS PARKING CONFLICTS THROUGHOUT CORRIDOR. REMOVE PARKING METERS OR RECONFIGURE SIGNAGE.



EX. CATCH BASIN. INSTALL CITY APPROVED CATCH BASIN SCREEN AND/OR DEBRIS COLLECTOR (BMP).



EXISTING MANHOLE PROTRUDES FROM PAVEMENT. ADJUST TO GRADE.

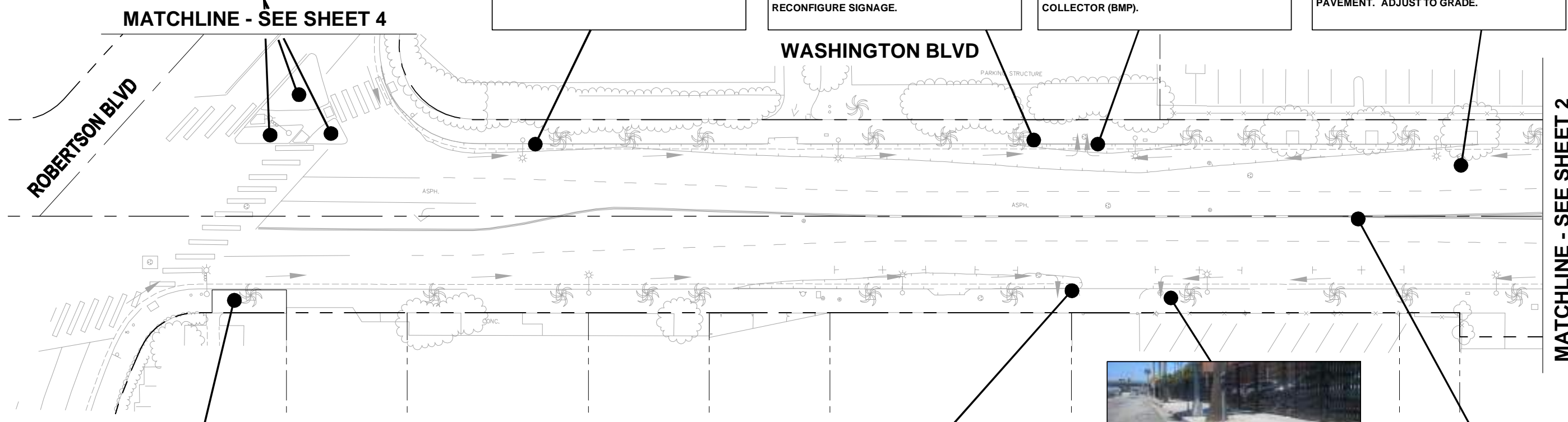

MATCHLINE - SEE SHEET 4

WASHINGTON BLVD

MATCHLINE - SEE SHEET 2



REMOVE AND REPLACE DAMAGED SIDEWALK.

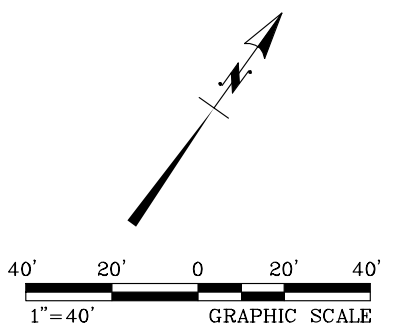

EX. CATCH BASIN. INSTALL CITY APPROVED CATCH BASIN SCREEN AND/OR DEBRIS COLLECTOR (BMP). OPPORTUNITY TO REMOVE ADJACENT TREE & REPLACE WITH STORM WATER BIORETENTION FILTRATION SYSTEM/TREE WELL (LID)



EX. CATCH BASIN. OPPORTUNITY TO REMOVE ADJACENT TREE & REPLACE WITH STORM WATER BIORETENTION FILTRATION SYSTEM/TREE WELL (LID)

OPPORTUNITY TO INSTALL MEDIAN. THIS WOULD REQUIRED REMOVING PARKING ALONG BOTH SIDES OF WASHINGTON BLVD.

CITY OF CULVER CITY WASHINGTON NATIONAL STREETScape PLAN TRANSIT ORIENTED DEVELOPMENT (TOD)

Last Revised: Wed Jul 02, 2014 - 2:55pm Last Plotted: Wed Jul 02, 2014 - 3:39pm Plotted By: stise Drawing: C:\Users\stise\AppData\Local\Temp\AcPublish_6072\Existing Conditions Assessment.dwg

KOA CORPORATION
 PLANNING & ENGINEERING
 1100 Corporate Center Drive, Suite 201
 Monterey Park, California 91754
 Tel: (323) 260-4703 Fax: (323) 260-4705

EXISTING CONDITIONS ASSESMENT



EXISTING DRIVEWAY IS AT 19.5% WHICH EXCEEDS CURRENT STANDARDS. RECOMMEND RECONSTRUCT DRIVEWAY.



REMOVE ALL REMAINING UNUSED PARKING METER POLES (TYPICAL).



DAMAGED GRATE INLET CATCH BASIN. OPPORTUNITY TO RECONSTRUCT CATCH BASIN WITH ADJACENT STORM WATER BIO-RETENTION FILTRATION SYSTEM (LID)

OPPORTUNITY TO INSTALL RAISED MEDIAN.

MATCHLINE - SEE SHEET 1

MATCHLINE - SEE SHEET 3

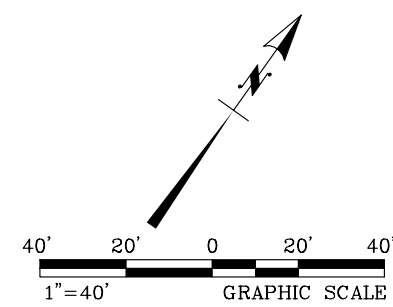
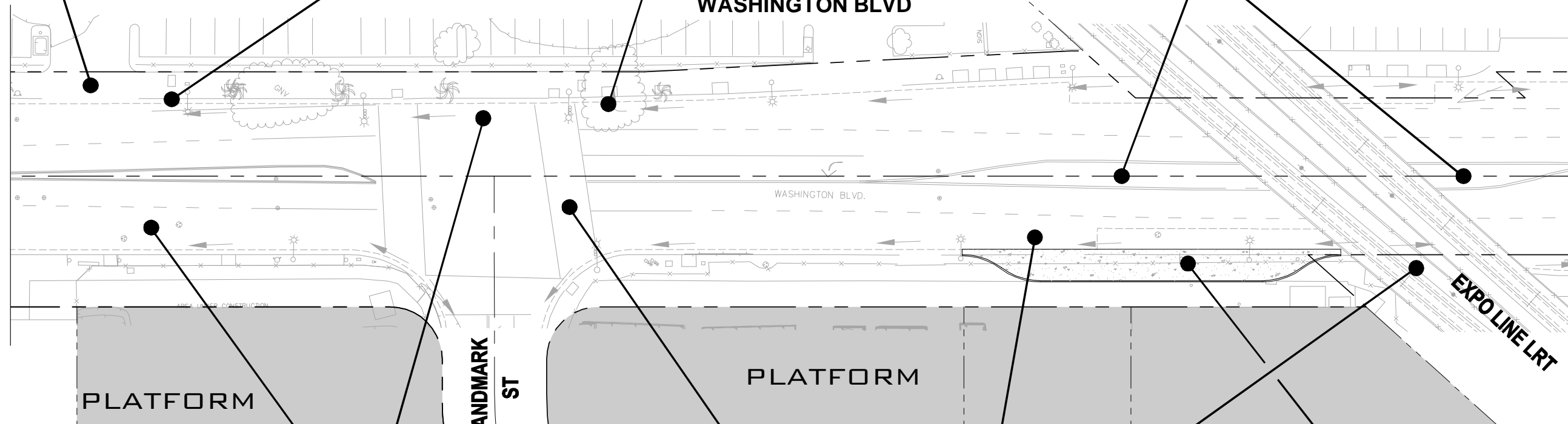

DAMAGED PAVEMENT. REMOVE AND REPAIR.



UPGRADE CROSSWALK TO CONTINENTAL CROSSWALK OR WITH DECORATIVE PAVERS. UPGRADE ALL PEDESTRIAN PUSH BUTTONS TO CITY APPROVED APS UNITS. TYPICAL FOR ALL PPB'S AT THIS LOCATION.



DAMAGED/TEMPORARY PAVEMENT/SIDEWALK. REMOVE AND REPLACE.

OPPORTUNITY TO CONSTRUCT BUS PULL OUT WITH CONCRETE BUS PAD. RELOCATE SIGNS, STREET LIGHTS AND STREET FURNITURE. REMOVE EXISTING BUS PAD AND REPLACE WITH AC PAVEMENT.

CITY OF CULVER CITY
WASHINGTON NATIONAL STREETScape PLAN
TRANSIT ORIENTED DEVELOPMENT (TOD)

Last Revised: Wed Jul 02, 2014 - 2:55pm Last Plotted: Wed Jul 02, 2014 - 3:39pm Plotted By: stise Drawing: C:\Users\stise\AppData\Local\Temp\AcPublish_8072\Existing Conditions Assessment.dwg

KOA CORPORATION
 PLANNING & ENGINEERING
 1100 Corporate Center Drive, Suite 201
 Monterey Park, California 91754
 Tel: (323) 260-4703 Fax: (323) 260-4705

EXISTING CONDITIONS ASSESSMENT



VACANT TREE WELLS. OPPORTUNITY FOR MULTIPLE BIO-RETENTION FILTRATION PLANTERS (LID) AND CONNECTION TO ADJACENT CATCH BASIN.



EX. CATCH BASIN. INSTALL CITY APPROVED CATCH BASIN SCREEN AND/OR DEBRIS COLLECTOR (BMP).

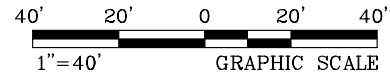

EXISTING RAMP DOES NOT MEET ADA REQUIREMENTS. RECONSTRUCT RAMP TO MEET ADA REQUIREMENTS.

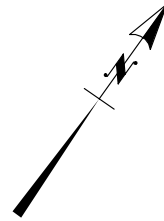

EX. CATCH BASIN. INSTALL CITY APPROVED CATCH BASIN SCREEN AND/OR DEBRIS COLLECTOR (BMP).



PEDESTRIAN PATH AT BACK OF DRIVEWAY IS 3'. RECOMMEND TO RECONSTRUCT DRIVEWAY TO ACCOMPLISH A 4' MINIMUM PEDESRIAN PATH AT 2%.

MATCHLINE - SEE SHEET 2

SEE SHEET 6

WASHINGTON BLVD

FUTURE TRAFFIC SIGNAL PER MITIGATION MEASURE FROM TRAFFIC IMPACT ANALYSIS REPORT (JULY 2010) FOR 8770 WASHINGTON BOULEVARD MIXED-USE DEVELOPMENT.

WASHINGTON BLVD.

NATIONAL BLVD

GREYSTAR

WESLEY ST

SEE SHEET 7

SEE SHEET 8



EXISTING 3' CLEARANCE BETWEEN TRAFFIC SIGNAL POLE AND CONTROLLER CABINET. RECOMMENDED TRAFFIC SIGNAL MODIFICATION TO INCREASE CLEARANCE.



RECOMMEND TO UPGRADE ALL PEDESTRIAN PUSH BUTTONS TO CITY APPROVED APS UNITS. TYPICAL FOR ALL PPB'S AT THIS INTERSECTION.



OPPORTUNITY FOR 8' BULB-OUT FOR LANDSCAPING OR ADDITIONAL STREET FURNITURE



FUTURE RECONSTRUCTED CATCH BASIN. INSTALL CITY APPROVED CATCH BASIN SCREEN AND/OR DEBRIS COLLECTOR (BMP).

CITY OF CULVER CITY

WASHINGTON NATIONAL STREETSCAPE PLAN
TRANSIT ORIENTED DEVELOPMENT (TOD)

Vertical text on the left margin: Last Revised: Wed Jul 02, 2014 - 2:55pm, Last Plotted: Wed Jul 02, 2014 - 3:39pm, Plotted By: stise, Drawing: C:\Users\stise\appdata\local\temp\AcPublish_8072\Existing Conditions Assessment.dwg

KOA CORPORATION
PLANNING & ENGINEERING
1100 Corporate Center Drive, Suite 201
Monterey Park, California 91754
Tel: (323) 260-4703 Fax: (323) 260-4705

EXISTING CONDITIONS ASSESSMENT

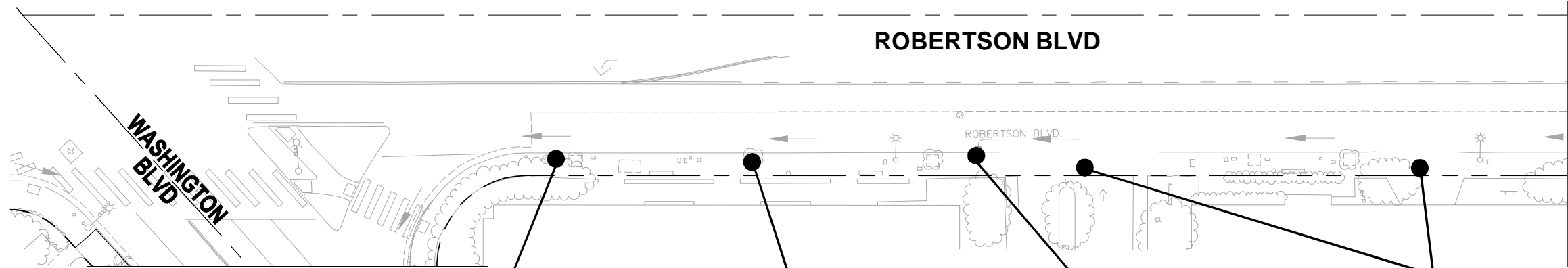

SEE SHEET 1



EX. CATCH BASIN. INSTALL CITY APPROVED CATCH BASIN SCREEN AND/OR DEBRIS COLLECTOR (BMP). OPPORTUNITY TO REMOVE ADJACENT TREE & REPLACE WITH STORM WATER BIORETENTION FILTRATION SYSTEM/TREE WELL (LID)



EXISTING TREES INTERFERE WITH BUSES. RECOMMEND TO REPLACE TREE WITH DIFFERENT SPECIES (TYPICAL).



EX. CATCH BASIN. INSTALL CITY APPROVED CATCH BASIN SCREEN AND/OR DEBRIS COLLECTOR (BMP).



EXISTING DRIVEWAY HAS 3' PEDESTRIAN PATH. RECOMMEND RECONSTRUCTION OF DRIVEWAY WITH A MINIMUM 4' PEDESTRIAN PATH.

MATCHLINE
SEE BELOW LEFT

MATCHLINE
SEE ABOVE RIGHT

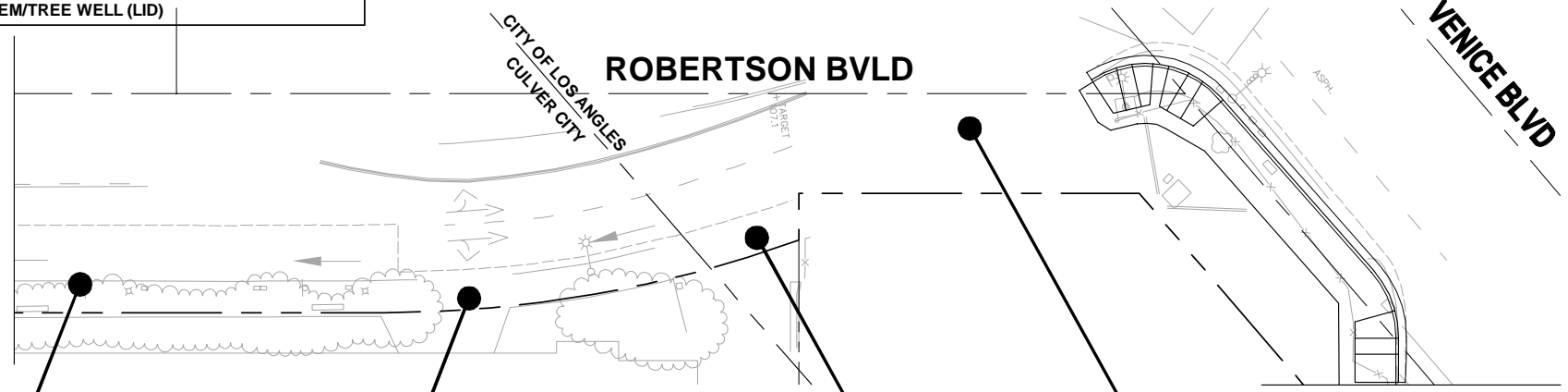

SEE SHEET 5

RECONSTRUCT CURB, GUTTER, AND SIDEWALK UNDER EXOP LINE. REMOVE AND REPAIR ROADWAY PAVEMENT AS NEEDED.



GUIDE SIGNS ARE CONFUSING AND NON-UNIFORM. CONSIDER ORGANIZING AND CONFORMING GUIDE SIGNS THROUGHOUT THE TOD.



EXISTING DRIVEWAY HAS 3' PEDESTRIAN PATH. RECOMMEND RECONSTRUCTION OF DRIVEWAY WITH A MINIMUM 4' PEDESTRIAN PATH.



EXISTING DRIVEWAY DOES NOT MEET ADA REQUIREMENTS. RECOMMEND RECONSTRUCTION OF DRIVEWAY TO MEET CURRENT STANDARDS

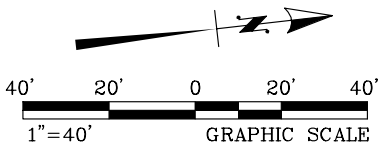

KOA CORPORATION
PLANNING & ENGINEERING
1100 Corporate Center Drive, Suite 201
Monterey Park, California 91754
Tel: (323) 260-4703 Fax: (323) 260-4705

CITY OF CULVER CITY
WASHINGTON NATIONAL STREETSCAPE PLAN
TRANSIT ORIENTED DEVELOPMENT (TOD)

EXISTING CONDITIONS ASSESSMENT

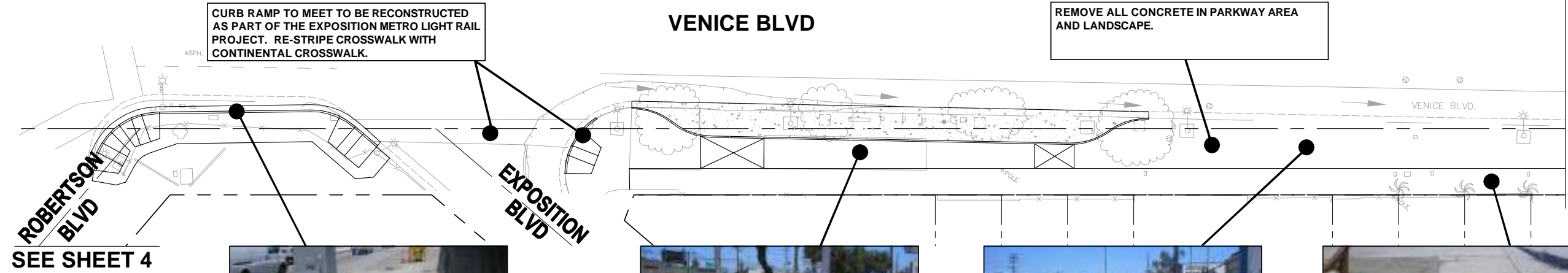

CURB/GUTTER, SIDEWALK, AND CURB RAMPS ARE TO BE RECONSTRUCTED AS PART OF THE EXPOSITION METRO LIGHT RAIL PROJECT.



OPPORTUNITY TO CONSTRUCT BUS PULL OUT WITH CONCRETE BUS PAD. RELOCATE SIGNS AND STREET FURNITURE.



REMOVE PARKING/CONCRETE. RECONSTRUCT DRIVEWAY AS NECESSARY TO ENTER PROPERTY.



REMOVE AND REPLACE 10' SIDEWALK FROM ROBERTSON BLVD TO NATIONAL BLVD.

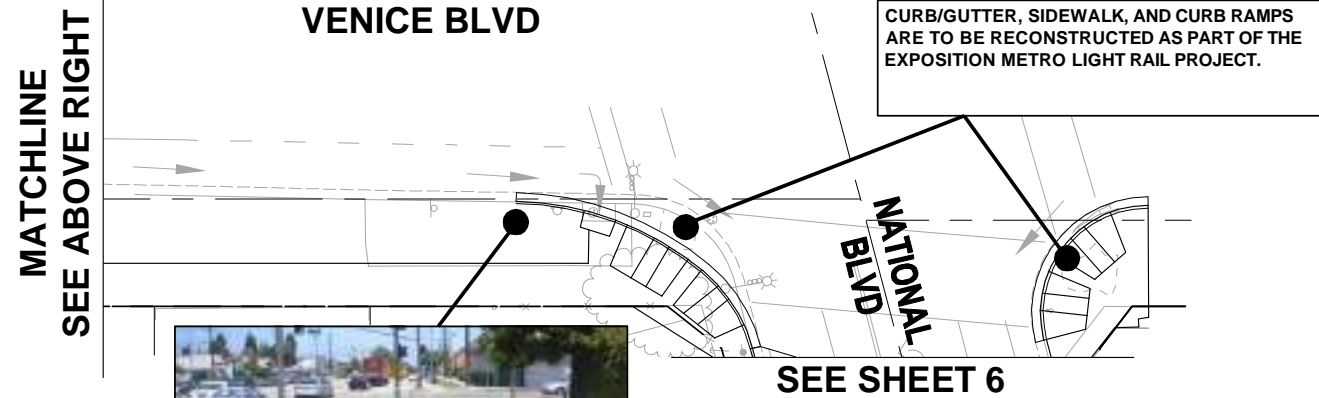

OPPORTUNITY TO INSTALL MULTIPLE BIO-RETENTION FILTRATION PLANTERS (LID) AND CONNECT UNDER-DRAIN TO EXISTING CATCH BASIN.

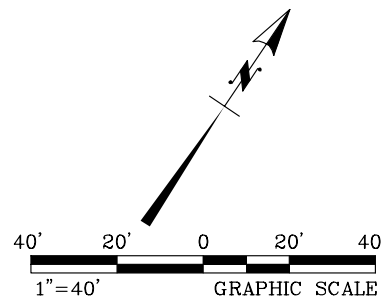

KOA CORPORATION
PLANNING & ENGINEERING
1100 Corporate Center Drive, Suite 201
Monterey Park, California 91754
Tel: (323) 260-4703 Fax: (323) 260-4705

CITY OF CULVER CITY
WASHINGTON NATIONAL STREETSCAPE PLAN
TRANSIT ORIENTED DEVELOPMENT (TOD)

EXISTING CONDITIONS ASSESSMENT



UPGRADE CROSSWALK TO CONTINENTAL CROSSWALK OR WITH DECORATIVE PAVERS.



RECONSTRUCT DRIVEWAYS TO MEET ADA REQUIREMENTS.



EX. CATCH BASIN. INSTALL CITY APPROVED CATCH BASIN SCREEN AND/OR DEBRIS COLLECTOR (BMP).



RECONSTRUCT DRIVEWAY TO MEET ADA REQUIREMENTS.

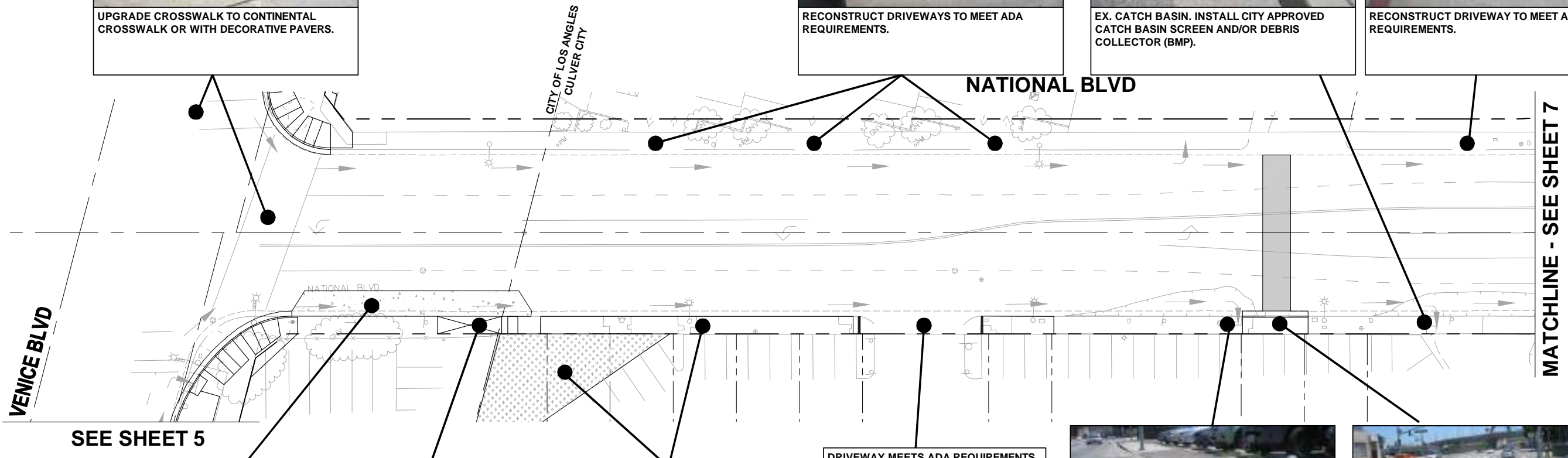

INSTALL CONCRETE BUS PAD.



RECONSTRUCT DRIVEWAY TO MEET ADA REQUIREMENTS.



REMOVE AND RECONSTRUCT CURB, GUTTER, AND SIDEWALK AS NEEDED. OPPORTUNITY TO ACQUIRE UNUSED AREA FOR LANDSCAPING AND/OR LID FEATURES.

DRIVEWAY MEETS ADA REQUIREMENTS. INSTALL GROOVES AT BOTH ENDS.

RECOMMEND SAFETY FENCING ALONG BACK OF WALK DUE TO PROXIMITY TO PARKING LOT.



EX. CATCH BASIN. INSTALL CITY APPROVED CATCH BASIN SCREEN AND/OR DEBRIS COLLECTOR (BMP).



REMOVE RAIL ROAD TRACK COMPLETE, RECONSTRUCT ROADWAY, CURB, GUTTER, AND SIDEWALK AS NEEDED.

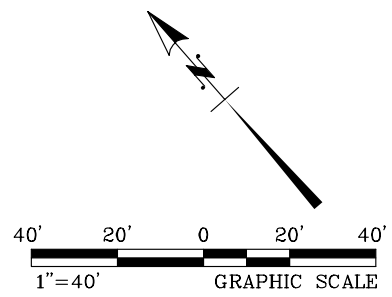

CITY OF CULVER CITY
WASHINGTON NATIONAL STREETSCAPE PLAN
TRANSIT ORIENTED DEVELOPMENT (TOD)

Last Revised: Wed Jul 02, 2014 - 2:55pm Last Plotted: Wed Jul 02, 2014 - 3:39pm Plotted By: stise Drawing: C:\Users\stise\AppData\Local\Temp\AcPublish_6072\Existing Conditions Assessment.dwg

KOA CORPORATION
 PLANNING & ENGINEERING
 1100 Corporate Center Drive, Suite 201
 Monterey Park, California 91754
 Tel: (323) 260-4703 Fax: (323) 260-4705

EXISTING CONDITIONS ASSESMENT



CONSIDER CONSOLIDATING SIGNAGE.

SEE SHEET 3



FUTURE CURB RETURN AND ADA CURB RAMP PER TRAFFIC IMPACT ANALYSIS REPORT (JULY 2010) FOR 8770 WASHINGTON BOULEVARD MIXED-USE DEVELOPMENT.



ALL CURB/GUTTER AND SIDEWALK IS TO BE REPLACED IN CONJUNCTION MIXED-USED DEVELOPMENT AT 8770 WASHINGTON BOULEVARD.

MATCHLINE - SEE SHEET 6

SEE SHEET 3

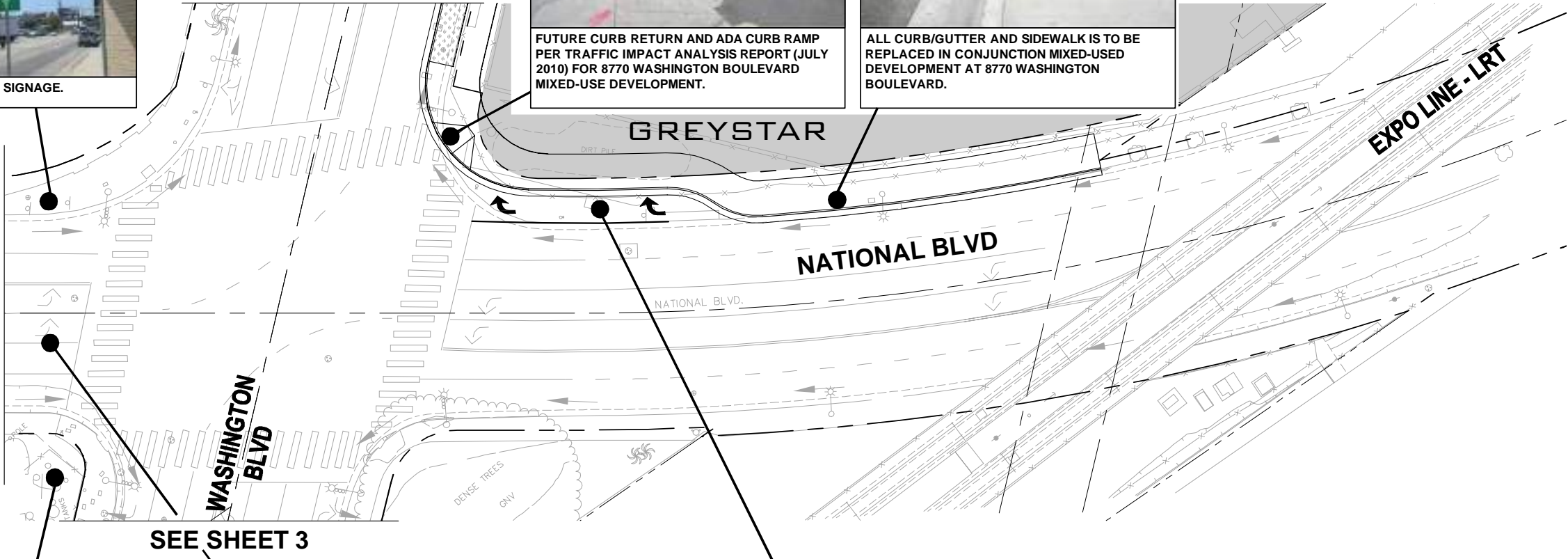

EXISTING CONSTRUCTION STORAGE AREA. OPPORTUNITY TO ACQUIRE UNUSED AREA FOR LANDSCAPING AND/OR LID FEATURES.



REPAIR DAMAGED AC PAVEMENT. RE-CUT DETECTOR LOOPS IF NECESSARY.

FUTURE 11' RIGHT TURN POCKET PER TRAFFIC IMPACT ANALYSIS REPORT (JULY 2010) FOR 8770 WASHINGTON BOULEVARD MIXED-USE DEVELOPMENT.

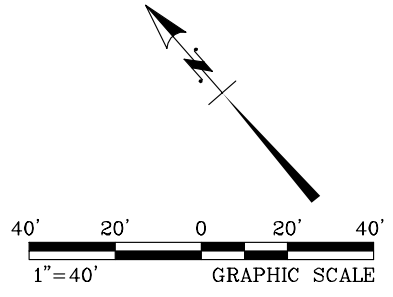

CITY OF CULVER CITY WASHINGTON NATIONAL STREETScape PLAN TRANSIT ORIENTED DEVELOPMENT (TOD)

KOA CORPORATION
 PLANNING & ENGINEERING
 1100 Corporate Center Drive, Suite 201
 Monterey Park, California 91754
 Tel: (323) 260-4703 Fax: (323) 260-4705

Last Revised: Wed Jul 02, 2014 - 2:55pm Last Plotted: Wed Jul 02, 2014 - 3:39pm Plotted By: stise Drawing: C:\Users\stise\AppData\Local\Temp\AcPublish_8072\Existing Conditions Assessment.dwg

EXISTING CONDITIONS ASSESSMENT



FUTURE ROAD WIDENING (36' ROAD WIDTH WITH 7' SIDEWALKS) IN CONJUNCTION WITH 8770 WASHINGTON BOULEVARD MIXED-USE DEVELOPMENT.

FUTURE TRAFFIC SIGNAL PER MITIGATION MEASURE FROM TRAFFIC IMPACT ANALYSIS REPORT (JULY 2010) FOR 8770 WASHINGTON BOULEVARD MIXED-USE DEVELOPMENT.

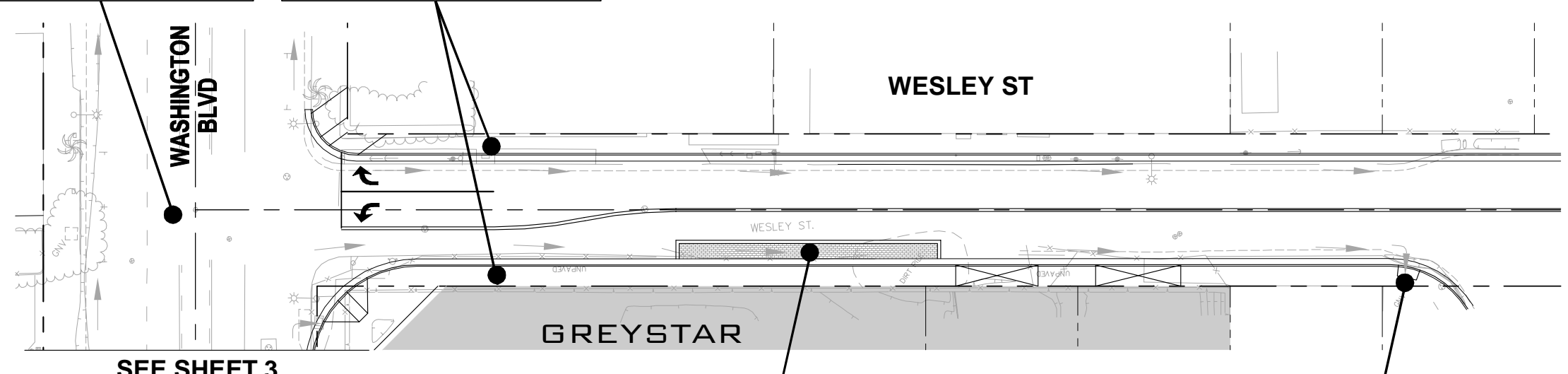

SEE SHEET 3

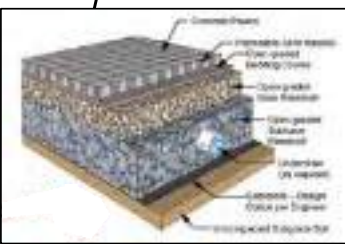

PROJECT RELATED LOADING ZONE FOR MIXED USED DEVELOPMENT. OPPORTUNITY FOR PERMEABLE PAVERS TO DISTINGUISH LOADING AREA AND INCORPORATE "LID".



EX./RECONSTRUCTED CATCH BASIN. INSTALL CITY APPROVED CATCH BASIN SCREEN AND/OR DEBRIS COLLECTOR (BMP).

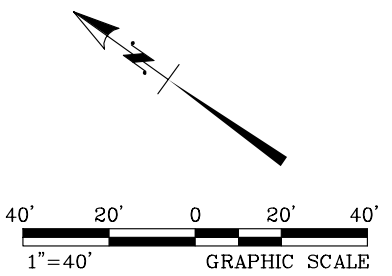

KOA CORPORATION
PLANNING & ENGINEERING
1100 Corporate Center Drive, Suite 201
Monterey Park, California 91754
Tel: (323) 260-4703 Fax: (323) 260-4705

CITY OF CULVER CITY
WASHINGTON NATIONAL STREETScape PLAN
TRANSIT ORIENTED DEVELOPMENT (TOD)



Simple-Lok

"Simple" excels because of cost and ease of lock-ability.



Simple, Universal Bike Parking!

This design has become the universally accepted type of bicycle parking - a simple, lockable "inverted-U" which supports the frame of the bike. It can be employed in ANY type of bicycle parking situation. It is SO simple!

Sunshine offer this design in shorter forms (as the [Street-Lok](#)) and with less steel (as the [Mini-Lok](#)). All are effective and all boast the unique, protective Sunshine coating. No rust on the rack, no dings/scratches on the bicycle frame, no complaints from cyclists.

Specifications

- Capacity: normally 2 bikes; however, bicycles can be locker in pairs on either side to accommodate 4!
- Material: Round pipe, finished OD 2-1/8"
- Construction: Heavy gauge steel pipe
- Coating/Finish: [Rugged heat-fused/bonded polyvinyl protective coating](#)
- Size: 36" (H), 18" (W) center on verticals
- Mounting: Base-plates or In-ground configurations.
- Colors: Standard black. A wide spectrum of colors are available with large quantity orders.
- **Guarantee on Finish: 10 Years!**

Options /Optional Accessories

- Anchor kits are an optional item.
- For asphalt, gravel, dirt or grass areas, recommend bolting units to channel.
- Recommend spacing units 30" center to center; yet a range of 24" to 40" is workable as well.

More Information

- [View the entire line of Sunshine U-Lok bicycle racks.](#)
- [Bicycle racks for Colleges, Universities & Secondary Schools](#)
- [Bicycle racks for Corporate Employers](#)
- [Bicycle racks for Municipalities/Governments](#)
- [Bicycle racks for Shopping Centers, Strip Malls & Fast Food](#)
- [Bicycle racks for Multi-Unit Housing \(Apartments/Condominiums\)](#)
- [Bicycle racks for Contractors, Architects & Planners](#)
- [Bicycle racks for Police & Law Enforcement](#)
- [Bicycle racks for Home Bicycle Storage](#)

Scarborough

Special Product Drawing

landscapeforms®

Dual Use Litter Receptacle, Side Opening, 30 Gallon, Vertical Strap, with Lock, Vinyl Decal on Lid

www.landscapeforms.com

Ph: 800.521.2546

- ___ APPROVED
- ___ REVISE & RESUBMIT
- ___ REJECTED

COMMENTS MADE ON THESE SUBMITTALS ARE FOR INFORMATION ONLY. ANY CHANGES REQUIRE RE-SUBMITTAL AND APPROVAL. CUSTOMER IS RESPONSIBLE FOR CONFIRMING ALL QUANTITIES, DIMENSIONS, AND INSTALLATION TECHNIQUES.

landscapeforms®

BY: _____

DATE: _____

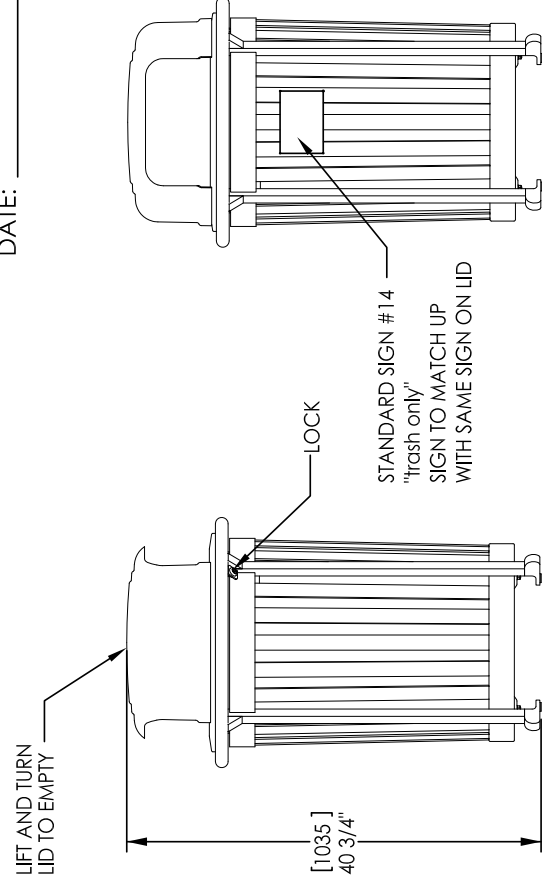
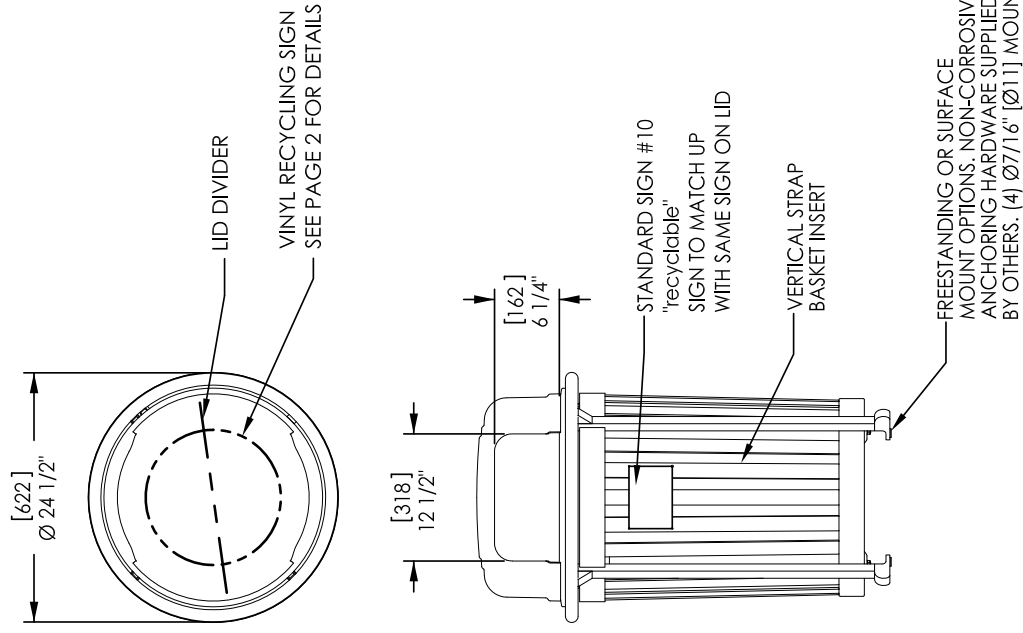

Drawing: SC999-06247-04
Date: 11/15/2012
Dimensions are in Inches[mm]

FREESTANDING OR SURFACE MOUNT OPTIONS, NON-CORROSIVE ANCHORING HARDWARE SUPPLIED BY OTHERS, (4) Ø77/16" (Ø111) MOUNTING HOLES.

CONFIDENTIAL DRAWING INFORMATION CONTAINED HEREIN IS THE PROPERTY OF LANDSCAPE FORMS, INC. INTENDED USE IS LIMITED TO DESIGN PROFESSIONALS SPECIFYING LANDSCAPE FORMS, INC. PRODUCTS AND THEIR DIRECT CLIENTS. DRAWING IS NOT TO BE COPIED OR DISCLOSED TO OTHERS WITHOUT THE CONSENT OF LANDSCAPE FORMS, INC. © 2012 LANDSCAPE FORMS, INC. ALL RIGHTS RESERVED.

Special Product Drawing

landscapeforms®

www.landscapeforms.com Ph: 800.521.2546

- ___ APPROVED
- ___ REVISE AND RESUBMIT
- ___ REJECTED

COMMENTS MADE ON THESE SUBMITTALS ARE FOR INFORMATION ONLY. ANY CHANGES REQUIRE RE-SUBMITTAL AND APPROVAL. CUSTOMER IS RESPONSIBLE FOR CONFIRMING ALL QUANTITIES, DIMENSIONS, AND INSTALLATION TECHNIQUES.

BY: _____ DATE: _____





Drawing: -04 LID
Date: 11/15/2012
Dimensions are in Inches[mm]

CONFIDENTIAL DRAWING INFORMATION CONTAINED HEREIN IS THE PROPERTY OF LANDSCAPE FORMS, INC. INTENDED USE IS LIMITED TO DESIGN PROFESSIONALS SPECIFYING LANDSCAPE FORMS, INC. PRODUCTS AND THEIR DIRECT CLIENTS. DRAWING IS NOT TO BE COPIED OR DISCLOSED TO OTHERS WITHOUT THE CONSENT OF LANDSCAPE FORMS, INC. © 2012 LANDSCAPE FORMS, INC. ALL RIGHTS RESERVED.

Towne Square™ Bench Specifications

Strap and perforated seat styles offered in 32", 49" or 70" lengths. One divider is available for the 49" bench; the 70" bench, may be specified with two intermediate dividers.

A single panel is formed to make a comfortable seat. Seating panels are vertical steel straps (1-1/2" x 1/8"), or perforated steel. The Towne Square bench comes standard with freestanding glides. Bench may be surface mounted with glides in place.

			
32" bench	49" bench	70" bench	
27" x 32" x 32"	27" x 32" x 49"	27" x 32" x 70"	d x h x l

Our Purpose Is To Enrich Outdoor Spaces

We believe in the power of design and its ability to influence and elevate the quality of public space. High quality products and outstanding customer experience makes us one of the world's premier designers and manufacturers of outdoor commercial furnishings.



one intermediate divider



two intermediate dividers

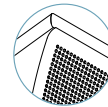

perforated seat panel

Finishes

Metal is finished with Landscape Forms' proprietary Pangard II® polyester powdercoat, a hard yet flexible finish that resists rusting, chipping, peeling and fading. Call for standard color chart.

To Specify:

Specify bench length, vertical strap or perforated seat style, with or without center/intermediate dividers, and powdercoat color.

landscapeforms.com

Visit our website for product details, color charts, technical sheets, sales office locations. Download JPG images, brochure PDF, CAD details, CSI specifications.

Specifications are subject to change without notice.
 Towne Square is manufactured in U.S.A.
 Towne Square is designed by Brian Kane, IDSA.
 Towne Square meets ANSI/BIFMA performance and safety standards.
 Location photography: Watercolor Resort, Santa Rosa Beach, FL.
 Landscape Forms supports the LAF at the Second Century level.
 ©2009 Landscape Forms, Inc. Printed in U.S.A.

 Metal is the world's most recycled material and is fully recyclable. Consult our website for recycled content for this product. Powdercoat finish on metal parts contains no heavy metals, is HAPS-free and has extremely low VOCs.

 Landscape Forms is proud to specify FSC and Green-e certified paper. This paper meets the Forest Stewardship Council's standards for responsible forest management and is made using certified renewable energy.

landscapeforms®
 800.521.2546 269.381.3455 fax
 431 Lawndale Ave., Kalamazoo, MI 49048
 landscapeforms.com



<p style="text-align: center;">light well with cover</p> <p style="text-align: center;">see note</p> <p style="text-align: center;">1 1/2" [38.10mm]</p> <p style="text-align: center;">30" [762.00mm]</p> <p style="text-align: center;">7/16" [11.11mm]</p> <p style="text-align: center;">1 1/4" [31.75mm]</p> <p style="text-align: center;">1/2" x 1" x 1/4" THICK GRINDING PADS FOR LEVELING - TYP. 4 OR MORE PLACES</p>	<p>6064 MARKET STREET TREE GRATE</p> <p>60" x 60" tree grate in two sections. two lightwells with bolted cover as shown.</p> <p>1/2 Maximum square opening for pedestrian safety and A.D.A Compliance.</p> <p>Cast from 100% recycled Iron, Aluminum, or Bronze for pedestrian loads only.</p> <p>Tree opening: 12", 18", 30" Grates can be ordered with or later expanded to these openings. please specify when ordering.</p> <p>Finish: unfinished or Black dip or Enamel paint or Polyurethane Paint or Powder coat Specify finish and color</p> <p>Use frame models: 6000F</p> <p>Weight: Iron= 485 lb/ 220 Kg Aluminum=184 lb/84 Kg</p>
<p>This drawing embodies a confidential proprietary design of IRONSMITH, INC. Palm Desert, Ca. All design, manufacturing, reproduction, use, sale, and other rights regarding the same are expressly reserved. This drawing is submitted under confidential relationship for a specific purpose and the recipient agrees by accepting this drawing not to supply or disclose any information regarding it to any unauthorized person or to incorporate any special feature peculiar to this design in other projects. The information in this drawing may be covered completely or in part by patents pending.</p>	<p>IRONSMITH 41-701 Corporate Way #3 Palm Desert, CA 92260 800.338.4766</p>

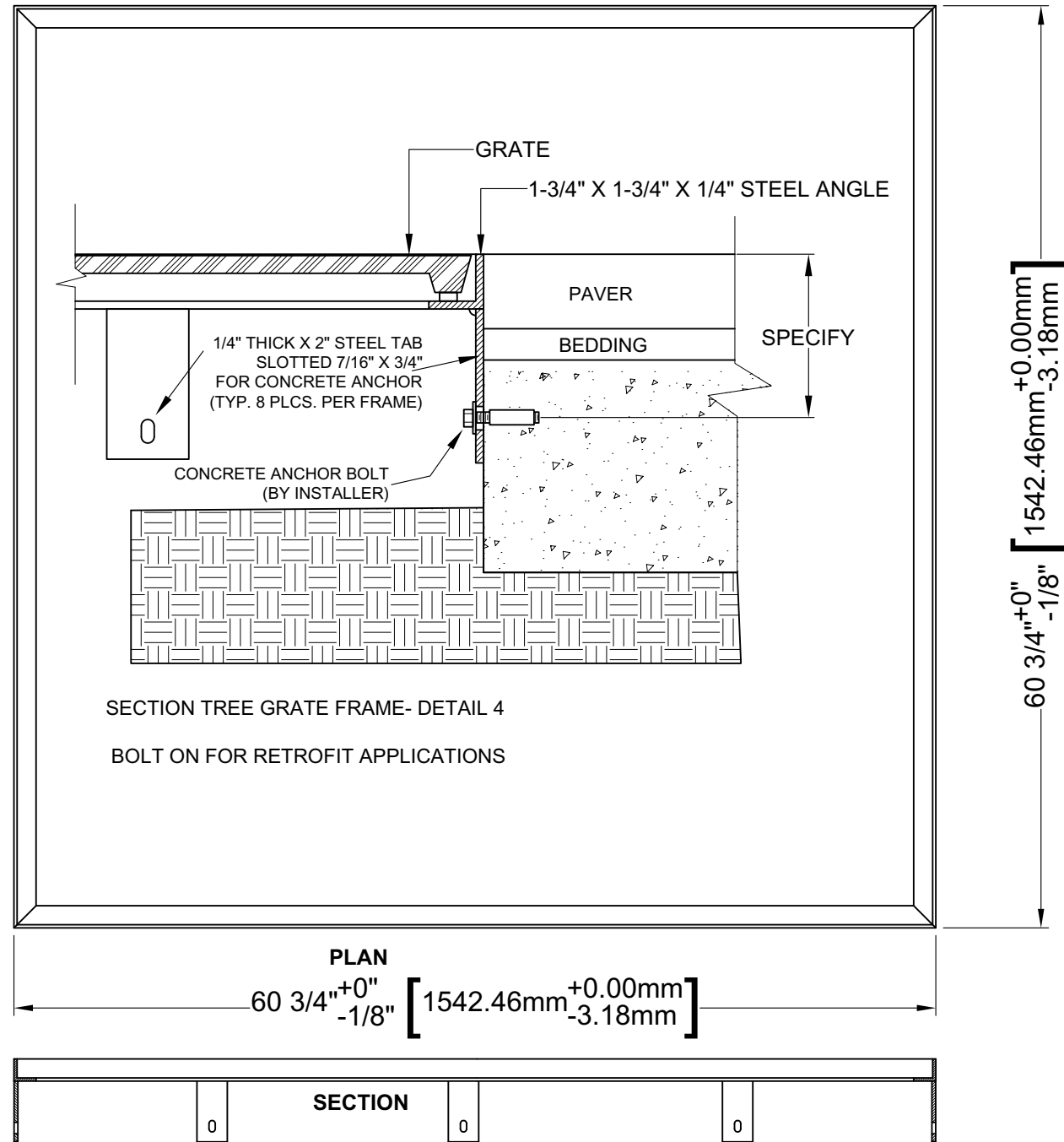

**SQUARE TREEGRATE
FRAME
M6000F-4**

WITH DETAIL #4
FOR PAVERS WITH
CONCRETE BASE

FRAME JIG WELDED
FROM 1-3/4" x 1-3/4" x 1/4"
STEEL ANGLE to ASTM
A36

ANCHORAGE PROVIDED
BY 1/4" THICK x 2" STEEL
TABS SHOP WELDED TO
FRAME

TABS SLOTTED 7/16" x
3/4" FOR CONCRETE
WEDGE (ANCHOR
PROVIDED BY
INSTALLER)

FRAME FINISH:
UNFINISHED
or GALVANIZED
or POWDER COAT

OTHER INSTALLATION
CONFIGURATIONS
AVAILABLE

This drawing embodies a confidential proprietary design of IRONSMITH, INC. Palm Desert, CA. All design, manufacturing, reproduction, use, sale and other rights regarding the same are expressly reserved. This drawing is submitted under confidential relationship for a specific purpose and the recipient agrees by accepting this drawing not to supply or disclose any information regarding it to any unauthorized person or to incorporate any special feature peculiar to this design in other projects. The information in this drawing may be covered completely or in part by patents pending.

IRONSMITH
41701 Corporate Way #3
Palm Desert, CA 92260
(800)-338-4766
www.ironsmith.biz

LEGEND

1. "GRATE STAKE".
3/4" DIAMETER SCHEDULE 40 STEEL PIPE. POWDER-COATED BLACK.
2. STRAP BAR.
.1865" X 12" FLAT BAR.
SECURED WITH (2) SET BOLTS.
3. ADJUSTABLE VINYL STRAP.
MINIMUM 1/4" X 1" X 18"
90 DURO FLEX PVC STRAP WITH UV INHIBITORS.
4. (2) 1/4" X 1-1/4" BOLTS, WASHERS AND NUTS.
5. STAKE PLATE.
6. SECURE TO GRATE WITH (4) 5/16" CARRIAGE BOLTS, WASHERS AND NUTS.
7. TREE GRATE.
A. HALF 1
B. HALF 2
8. TREE.

DETAIL IS FOR REFERENCE ONLY. SEE MANUFACTURER'S DETAILS AND SPECIFICATIONS. J.R. PARTNERS, 1616 FREEDOM COURT, TURLOCK, CA. 95382. (888) 333-3090

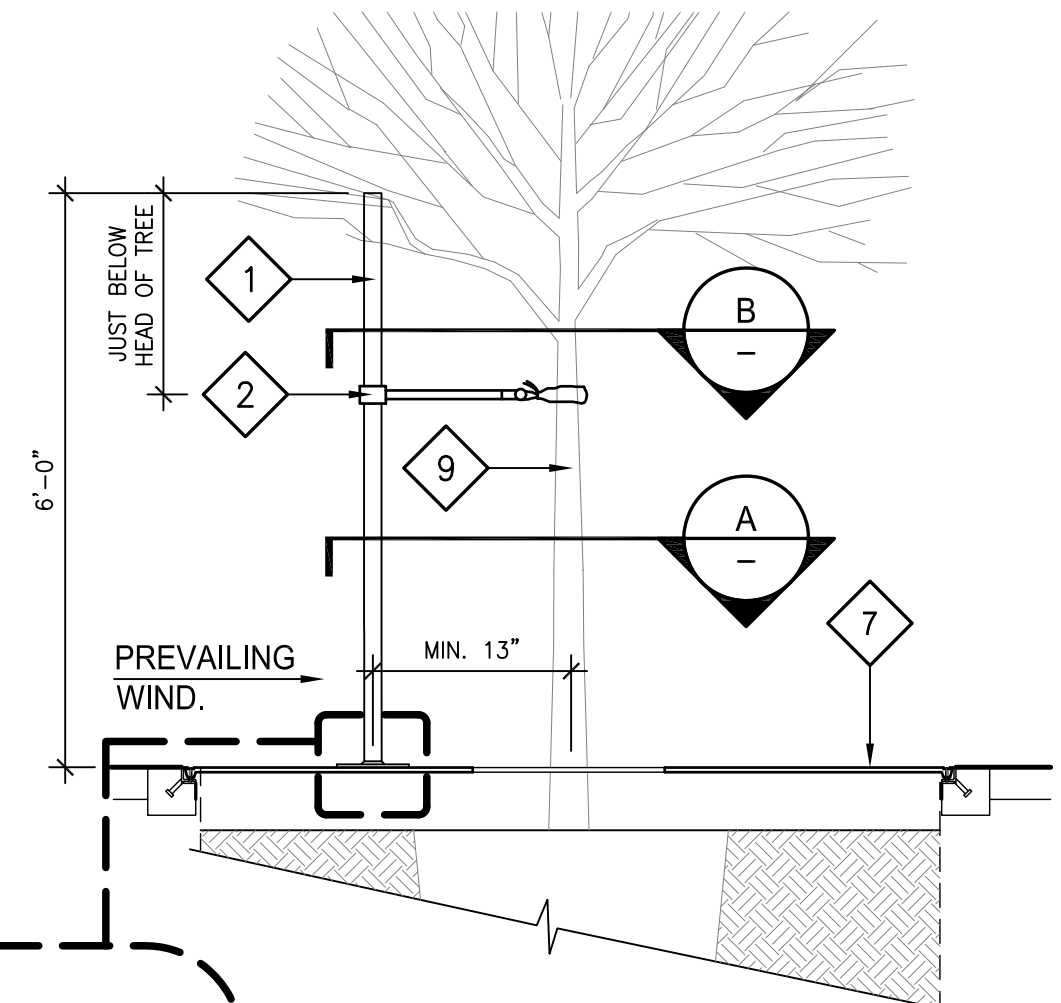
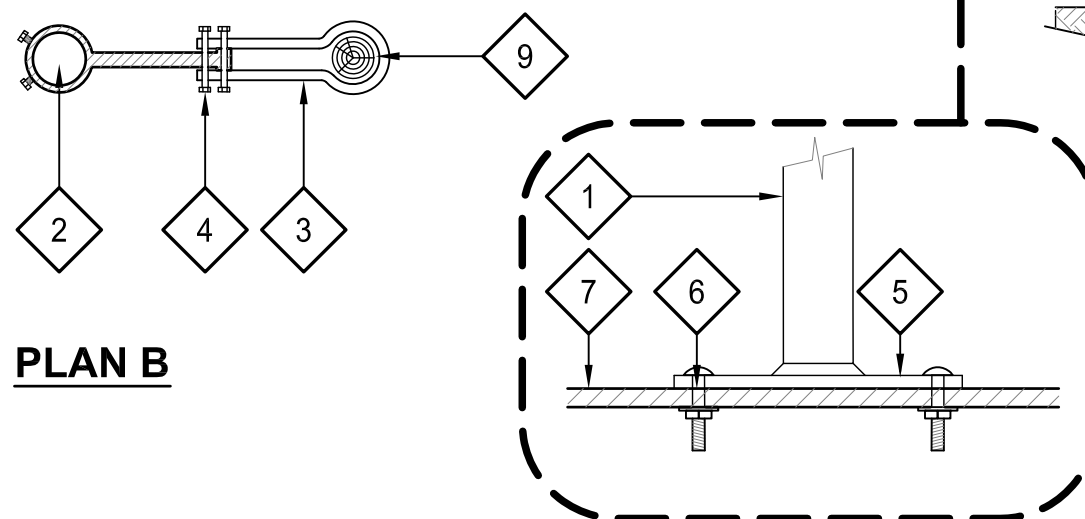
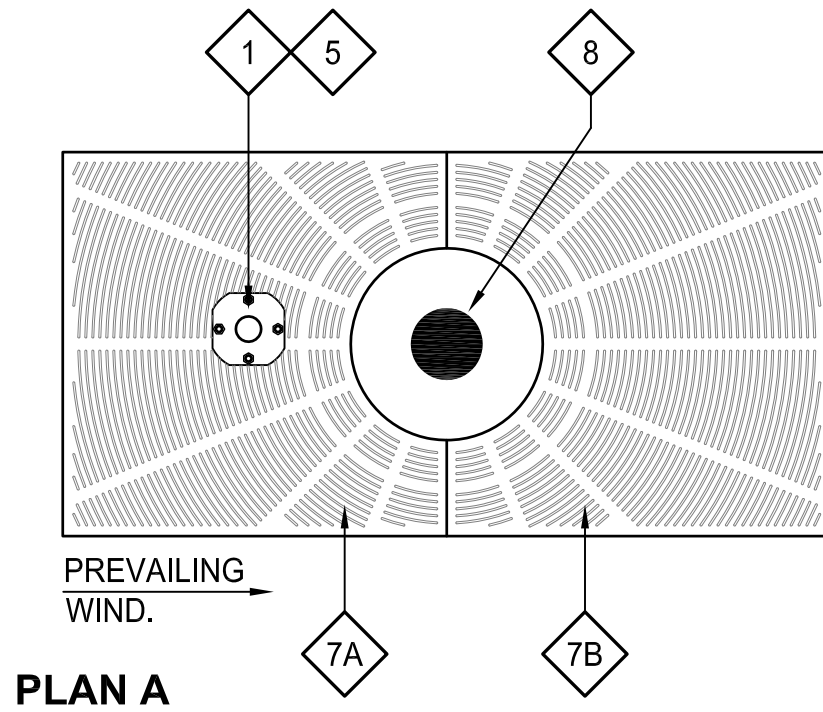

"GRATE STAKE" BY J.R. PARTNERS
SCALE: NTS

"GRATE STAKE" BY J.R. PARTNERS .dwg

Aqua-Via

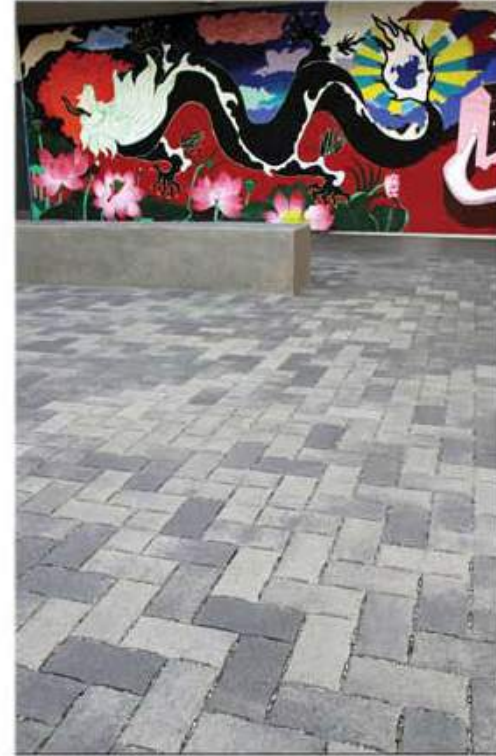

Specs

Stone Size	4 3/8" x 8 3/4"
Thickness	8 cm
Stones Per Sq. Ft.	3.7
Stones Per Pallet	350
Sq. Ft. Per Pallet	95
Weight Per Pallet	3226

Patterns

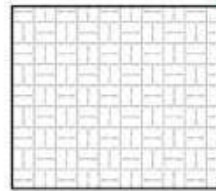

Basket Weave
100% Recs.

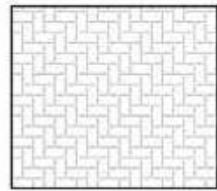

Herringbone
100% Recs.

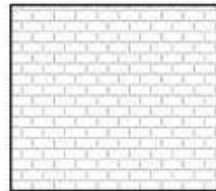

Running Bond
100% Recs.

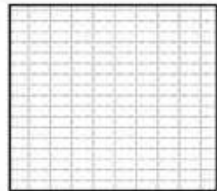

Stacked Bond
100% Recs.

Standard Colors



Antique Pewter



Catina Blend

Holland Stone I



Specs

Stone Size	3 7/8" x 7 7/8"		
Thickness	4 cm*	6 cm	8 cm
Stones Per Sq. Ft.	4.6	4.6	4.6
Stones Per Pallet	720	480	384
Sq. Ft. Per Pallet	156	104	83
Weight Per Piece	4.2	5.9	7.5
Weight Per Pallet	2940	2830	2840

Patterns

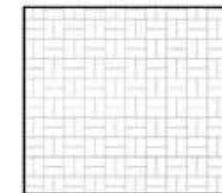

Basket Weave 100% Recs.

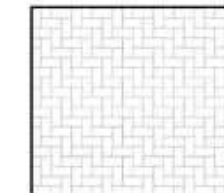

Herringbone 100% Recs.

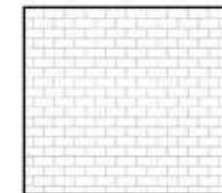

Running Bond 100% Recs.

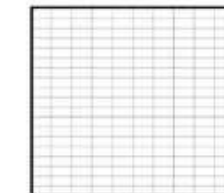

Stacked Bond 100% Recs.

6 cm Standard Colors



Antique Pewter Antique Red Apache Gold Catina Blend



Charcoal Brown Buff Charcoal Desert Blend Mocha Brown



Oak Creek Blend Terra Cotta Brown

8 cm Standard Colors



Antique Pewter Catina Blend

Acker-Stone Industries

California Facility
13296 Temescal Canyon Road
Corona, CA 92883

Arizona Facility
6700 W. Allison Road
Chandler, AZ 85226

800-258-2353

www.ackerstone.com



Rev. 2-2014

Our standard colors are routinely updated. Call or email us for the most up-to-date list. Custom Colors and Finishes are also available upon request.

Acker-Stone Industries

California Facility
13296 Temescal Canyon Road
Corona, CA 92883

Arizona Facility
6700 W. Allison Road
Chandler, AZ 85226

800-258-2353

www.ackerstone.com



Rev. 2-2014

Our standard colors are routinely updated. Call or email us for the most up-to-date list. * Special Order Product. Custom Colors and Finishes are also available upon request.



LOOKS BEAUTIFUL ON THE TOP SURFACE... AND ON THE BOTTOM LINE.

A BREAKTHROUGH, EASY TO USE CONCRETE SURFACE RETARDER THAT LOWERS APPLICATION COST FOR HIGHER MARGINS.

- UNIFORM HIGH-QUALITY FINISH
- UNMATCHED RELIABILITY AND CONTROL
- ENVIRONMENTALLY FRIENDLY
- AVAILABLE IN 11 DIFFERENT GRADES
- CREATES FINISHES FROM MICRO ETCH TO FULLY EXPOSED AGGREGATE.
- COST-EFFECTIVE COVERAGE RATES UP TO 3X BETTER THAN COMPETITORS
- OUTSTANDING TECHNICAL SUPPORT



DAYTON SUPERIOR PRODUCTS

- | | |
|---|---|
| <p>BRIDGE DECK FORMING
Adjustable Joist Hangers
Bridge Overhang Brackets
Haunch and Fillet Forming
Pres-Steel, Coil Rod and
Con-Beam Hangers
Screed Supports</p> <p>CHEMICALS
Bond Breakers
Cleaners / Strippers
Concrete Repair/Restoration
Curing Compounds / Sealers
Epoxies
Floor Levelers
Form Release Agents
Grouts
Hardeners/Industrial Toppings
Liquid Densifiers
Surface Retarders</p> <p>FORMING AND SHORING
Aluminum Shoring
Ganged Formwork
Garage Beam System
Handset Formwork
Highway Forms
Jump Forms
Modular Deck Shoring
One Sided Frames
Self Spanning Forms
Steel Frame Shoring</p> <p>FORMLINERS
ABS Plastic
Polystyrene Plastic</p> <p>PAVING
Dowel Bar Expansion Caps
Dowel Bar Retrofit System
Elastomeric and Hot Pour Joint Seal
Metal Keyway Form Systems
Tie Bar Assemblies
Transverse Bar Assemblies
Welded Dowel Assemblies
Wire Baskets without Dowels</p> | <p>PRECAST
Anchors and Lift Systems
Coil / Ferrule Inserts
Core Plugs
Magnets
Precast Forms
Rustications/Chamfers
Sandwich Panel Connector
Shear Connectors
Slotted Inserts</p> <p>REBAR SPlicing
Forged Dowel Bar Couplers
Lockshear Bolt Couplers
Shear Resistance Products
Straight Thread Couplers
Taper Thread Couplers</p> <p>REBAR SUPPORTS
Concrete Dobies
Continuous Plastic and Steel Bar
Supports
Individual Plastic and Steel Bar
Supports
Mesh Chairs
Paving Chairs
Side Form Spacers</p> <p>TIES AND ACCESSORIES
Modular Form Ties
Single Waler System
Ties and Accessories</p> <p>TILT-UP
Braces and Brace Anchors
Helical Ground Anchors
Setting Plugs
Strongback System
Tilt-Up Anchors and Lifting
Systems</p> |
|---|---|

CONTACT INFORMATION

<p>CORPORATE HEADQUARTERS 1125 Byers Road Miamisburg, OH 45342 937-866-0711</p>	<p>ACCESSORIES AND CHEMICALS Customer Service: 888-977-9600 Technical Assistance: 877-266-7732 info@daytonsuperior.com</p>
--	---

TC2
07/13



Top-Cast®

Surface Retarder

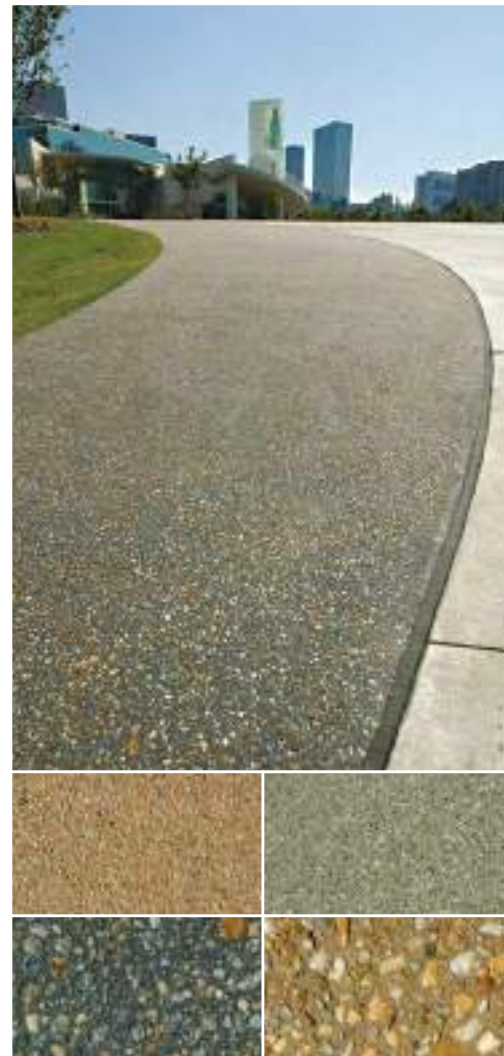

Manufactured by GRACE

**GET BETTER RESULTS.
NO MISTAKES.
IT'S SO EASY.**

*Adds profitable decorative opportunities
with no special equipment or training*



SPRAY

- Apply after sweat finish
- Spray or roll
- Pigmented to show coverage
- Rain-safe in 2 hours
- No plastic needed



RINSE

- Expose within 24 hours
- Rinse same day or pressure wash next day



SHOW

- Uniform finish every time
- Increases productivity with better results





Top-Cast[®]

Concrete Surface Retarders

CHOOSE YOUR FINISH

- Available in 11 different grades that create a range of finishes from micro-etch to fully exposed aggregate.
- Grade selection based on size of aggregate to expose and strength of mix.
- All grades are formulated separately to create distinctly different products.

		NO. CODE	ETCH AGGREGATE SIZE TO EXPOSURE	PACKAGE COLOR
MICRO ETCH		03	Acid Etch Finish	Violet
		05	Sandblast Finish	Light Blue
		15	Up to 1/4" (6.5 mm)	Yellow
MEDIUM EXPOSURE		25	1/8"– 1/4" (3 mm–6.5 mm)	Beige
		50	1/8"– 3/8" (3 mm–9.5 mm)	Canary Green
		75	1/8"– 3/8" (3 mm–9.5 mm)	Blue
		100	3/8"– 1/2" (9.5 mm–13 mm)	Gray
FULL-DEPTH EXPOSURE		125	3/8"– 5/8" (9.5 mm–16 mm)	Pink
		150	3/8"– 5/8" (9.5 mm–16 mm)	Green
		200	5/8" – 1" (16 mm–25 mm)	Salmon
		250	1" – 1 1/2" (25 mm–38 mm)	Orange

* Values listed are for standard 6-Sack Mix. In some conditions with certain mixes, it may be necessary to rinse the retarded matrix the same day.

**Do not over-finish and/or delay application beyond the initial bleeding on the light finishes. Coverage Rate: 175–300 ft²/gal (4.3–7.4 m²/L)

Always test under job site conditions to verify the appropriate grade for specific mix designs.

DIRECTIONS:

- Shake well before application.
- Before placing concrete, protect adjacent surfaces.
- Place concrete and float or trowel finish.
- Apply Top-Cast with a handheld plastic sprayer at a rate of 175–300 ft²/gal (4.3–7.4 m²/L).
- Once dry, 1–2 hours after application, Top-Cast provides protection against intermittent rain and requires no covering with plastic or poly. It also ensures protection in windy or hot weather.
- Depending on temperatures, concrete surface paste can be washed off in 4 to 24 hours with water hose and broom or high-pressure washer.
- Environmentally friendly! Use water for clean up.

DEEPROOT SILVA CELL

RESTORING ECOSYSTEM SERVICES TO THE URBAN ENVIROMENT

INTEGRATED TREE, SOIL AND STORMWATER SYSTEM



THE SILVA CELL®

INTEGRATING TREES, SOIL AND STORMWATER FOR SUSTAINABLE DEVELOPMENT

SOIL IS CRITICAL TO THE LONG TERM SUSTAINABILITY OF DEVELOPMENT SITES.

Provide the basis for healthy vegetation, treat stormwater as a resource, and restore ecosystem services with the Silva Cell.

The Silva Cell is a modular building block for containing unlimited amounts of healthy soil beneath paving while supporting traffic loads and accommodating surrounding utilities. The Silva Cell is filled with high-quality, uncompacted soil to grow trees and manage the rate, quality and volume of stormwater. The modular system can be easily sized to accommodate the needs of any site without compromising effectiveness or site design.

By combining on-site stormwater management with expanded rooting volumes for healthy tree growth, Silva Cells create an unparalleled ability to restore ecological function to developed areas.

SOIL, TREES AND STORMWATER

Increasing attention is being paid to soil, and the conclusion is inescapable – soil matters. A Report by the National Research Council commissioned by the United States Environmental Protection Agency concludes:

*"Nearly all of the associated problems [of urbanized watersheds] result from one underlying cause: loss of the water-retaining and evapotranspiring functions of the soil and vegetation in the urban landscape."*¹

The report goes on to state:

*"Stormwater Control Measures that harvest, infiltrate, and evapotranspire stormwater are critical to reducing the volume and pollutant loading of small storms."*²

1. Urban Stormwater Management in the United States (a report by the National Research Council: National Academies Press, 2008).

2. Ibid. 8.

The more healthy soil is available to trees, the bigger they can grow – and the bigger a tree grows, the more significant environmental and social benefit it provides. USDA Forest Service research shows that a tree with a 30-inch diameter removes 70 times the pollution of a tree with just a 3-inch diameter³. Typically, urban tree growth is stunted by limited access to soil and poor soil quality. Buckling sidewalks from roots are hazardous and a major cost to repair. The Silva Cell overcomes these challenges by providing unlimited soil volumes without compromising above ground surface area.

The Silva Cell integrates trees and soil with stormwater management, utilizing the proven capacity of soils to act as an underground bioretention system. When rainfall moves across impermeable paving, it picks up pollutants. As it is channeled off-site, it deposits these pollutants in oceans, lakes, rivers and wetlands. This non-point source runoff, a leading cause of urban pollution, is significantly mitigated by use of the Silva Cell. Through soil filtration, bioremediation and evapotranspiration, the Silva Cell treats stormwater directly on-site, restoring ecosystem services and saving money while protecting one of our most valuable resources.

3. David Nowak, "Trees Pollute? A 'TREE' Explains It All." (Proceedings of the 7th National Urban Forest Conference, Washington, D.C, USA, 1996).

APPLICATIONS

The Silva Cell can be used in a wide variety of applications. Some of the most common are:

- STREETSAPES AND PLAZAS
- BREAK-OUT ZONES
- PARKING LOTS
- GREEN ROOFS/ON-STRUCTURE
- GREEN WALLS

Each of these applications can be designed to optimize tree growth and stormwater management.

For more information on different types of Silva Cell applications see pages 7-8, or contact us at info@deeproot.com or (415) 781-9700.



HOW THE SILVA CELL WORKS

MODULAR DESIGN ACCOMMODATES ANY SITE

SUPPORT TRAFFIC LOADING WHILE PROVIDING UNCOMPACTED SOIL VOLUMES FOR LARGE TREE GROWTH AND ON-SITE STORMWATER MANAGEMENT.



Each Silva Cell is composed of a frame and a deck. Frames can be stacked one, two, or three units high before they are topped with a deck to create a maximum amount of soil volume for supporting tree root growth and stormwater management.

Material Specifications

Fiberglass reinforced, chemically-coupled, impact modified polypropylene.
Galvanized steel tubes.

Deck Dimensions

Length: 48" (1200 mm)
Width: 24" (600 mm)
Height: 2" (51.5 mm)

Frame Dimensions

Length: 48" (1200 mm)
Width: 24" (600 mm)
Height: 16" (400 mm)

Capacity

Void capacity: approximately 92%
Soil capacity: approximately 10 ft³ (.28 m³)

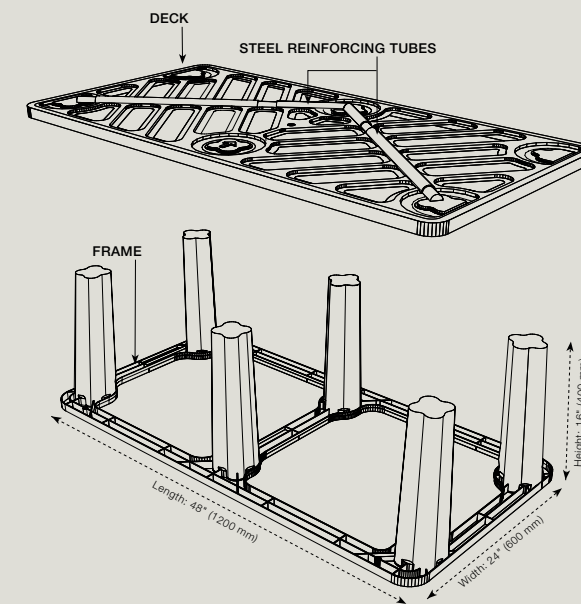

ENGINEERING AND LOADING

FRAME AND DECK FEATURES

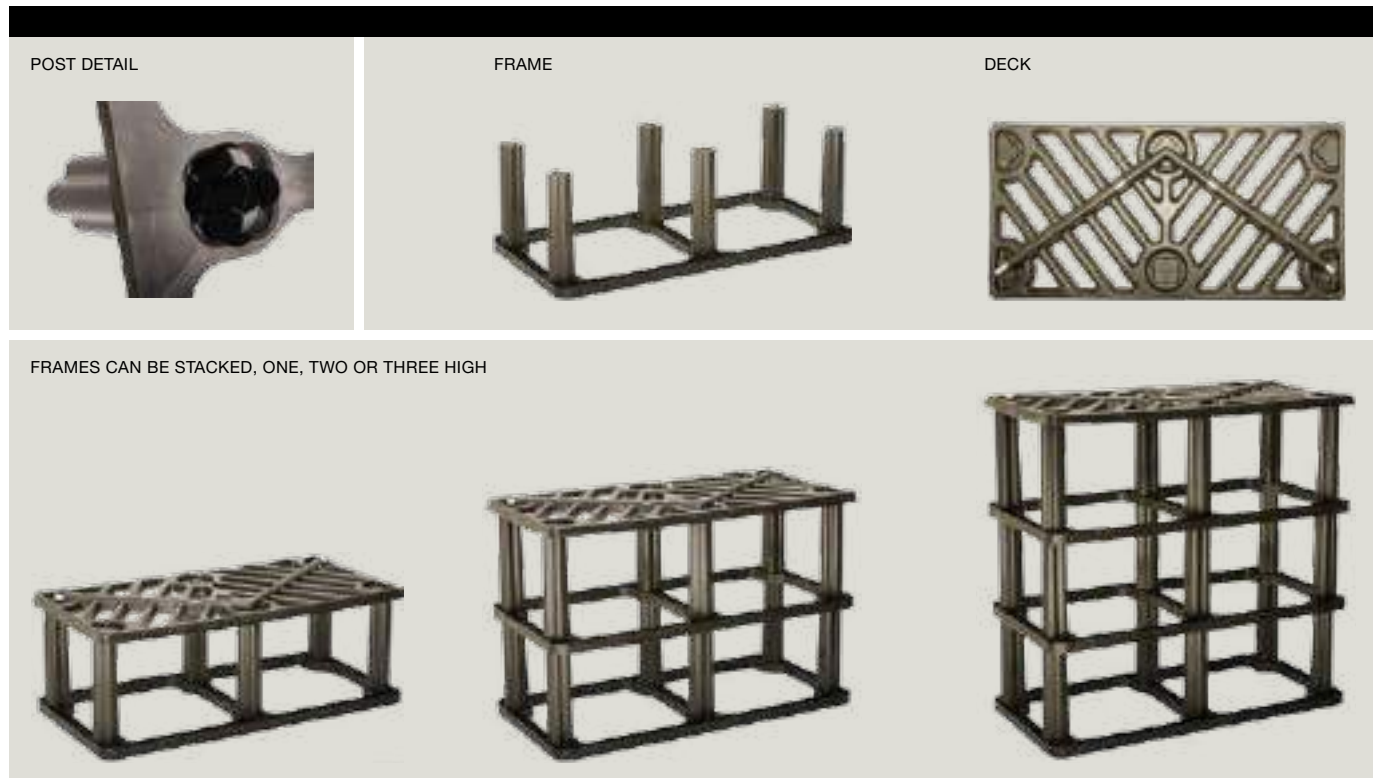

FRAME DESIGN FEATURES

Six rigid vertical posts protrude from the frame, providing structural support of paving and the loads it carries. Their cross-sectional shape maximizes axial rigidity and prevents the posts from telescoping together when the frames are stacked.

Their rounded edges prevent significant stress concentrations, meaning that paving supported by the Silva Cell does not settle due to compressive forces. The bottom portion of the frame is relatively pliable, allowing it to conform to irregularities in the earth without breaking or suffering loss of strength.

DECK DESIGN FEATURES

The deck is a rigid platform with six recesses positioned to rest securely on the six posts of the frame. Openings on the deck allow ample room for air and water to penetrate and nourish the enclosed soil. Two diagonal channels on the upper portion of the deck house galvanized steel tubes that prevent deformation of the posts and help eliminate plastic creep.

The Silva Cell can support vehicle loading up to AASHTO H-20 rating of 32,000 lbs. (14,500 kgs) per axle. This rating refers to the ability of a roadway to safely accommodate 3-4 axle vehicles, such as a large semi-truck and trailer.

The tables and associated paving conditions listed here are represented in our standard product details and specifications.

Loading standards vary worldwide and your particular project may have different needs. Please consult with Deep Root to review and optimize the use of the Silva Cell to your project requirements.

Physical load testing was completed by TRI Environmental in order to determine the ultimate allowable stress of the Silva Cell. The applied stress values from the applied loading on the pavement surface were determined using Sigma/W, a finite element program, for each of the design cases. These values were compared to the ultimate allowable stress (considering a minimum safety factor of 1.45). In all cases, the material self weight is used.

The values in the table to the right are the applied stresses due to various loading scenarios and are calculated based on having the ground surface loads dissipated through the pavement surface.



SUMMARY OF TOP DECK STRESSES UNDER H-20 LOADING CONDITIONS (32,000 LBS/14,500 KG)

	Pavers	Asphalt	Concrete	Pavers with Concrete
English	21.3 psi • 3.15" pavers • 1" sand base • 12" of aggregate	21.3 psi • 4" of asphalt concrete • 12" of aggregate	18.7 psi • 4" of Portland Cement Concrete • 4" of aggregate	15.0 psi • 2.36" pavers • 5" of Portland Cement Concrete
Metric	146.8 kN/m ² (kPa) • 8 cm pavers • 2.5 cm sand base • 30.5 cm of aggregate	146.8 kN/m ² (kPa) • 10 cm of asphalt concrete • 30.5 cm of aggregate	128.9 kN/m ² (kPa) • 10 cm of Portland Cement Concrete • 10 cm of aggregate	103.4 kN/m ² (kPa) • 6 cm pavers • 12.7 cm of Portland Cement Concrete

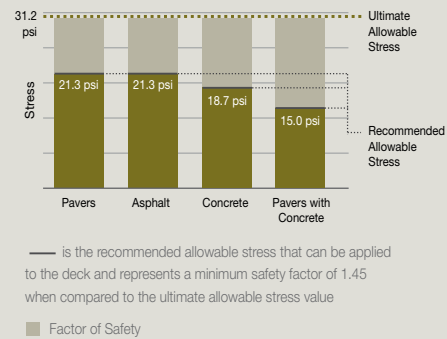

TYPICAL H-20 AXLE LOADING AT THE PAVEMENT SURFACE

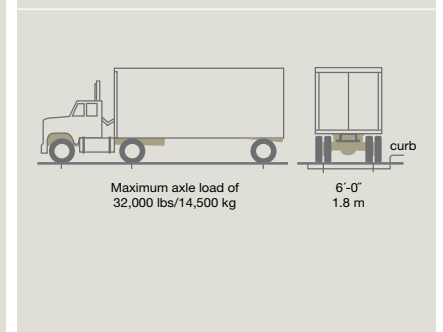

SELECTED PROJECTS

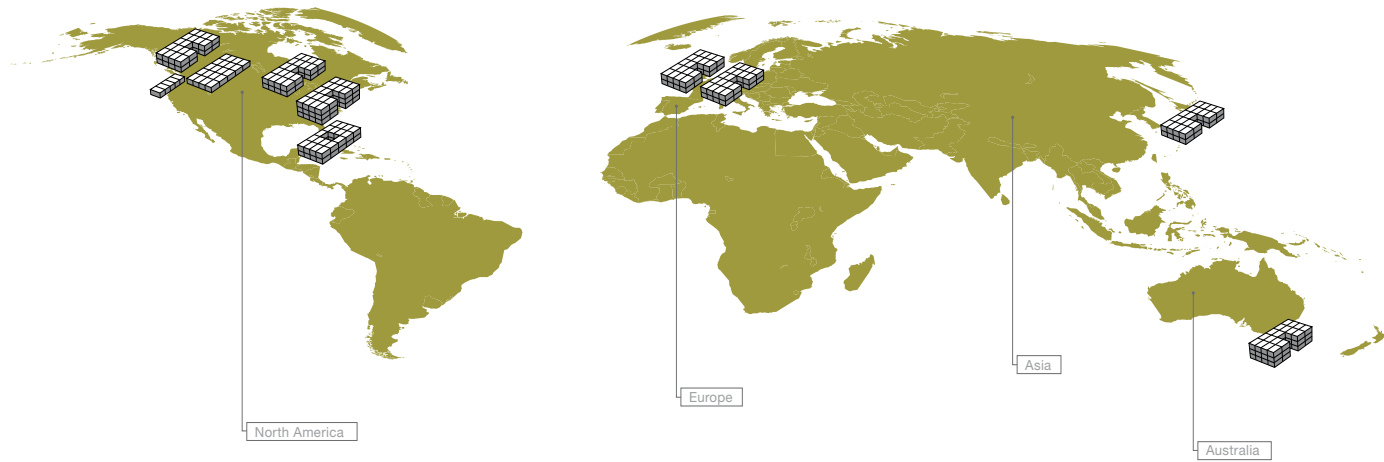

The Silva Cell can be used in a wide variety of tree and stormwater management applications of any size.

Silva Cells make it possible for **streetscapes, plazas and parking areas** to support healthy, thriving trees without compromising above ground surface areas. They can act as a bridge, linking street tree roots up with nearby soil volumes like parks and lawns in **break-out zone applications**, and they can support **green walls and green roofs** to help transform otherwise under-utilized spaces into living resources.

The Silva Cell can be applied to different green building certification programs, including LEED and BREEAM. Please contact us at info@deeproot.com to learn more.

 **STREETSCAPES / PROMENADES / COURTYARDS**

Streetscape and On-Structure (New York, NY)

Total soil volume per tree: 820 - 1,000 ft³ (23 - 28 m³)
 Total Silva Cells: 1,150 frames, 390 decks
 Installation type: Trees
 Client: Lincoln Center Development Project

Recent renovations of Lincoln Center emphasize a truly green approach to development – the Bosque and streetscape applications utilize the soil volume provided by the Silva Cells to achieve that design vision.

Streetscape (Toronto, Canada)

Total soil volume per tree: 688 ft³ (19.5 m³)
 Total Silva Cells: 260 frames, 130 decks
 Installation type: Trees and stormwater
 Watershed area treated: 8,288 ft² (770 m²)
 Water volume treated: 656 ft³ (18.5 m³)*
 Client: Toronto Water

Silva Cells were installed under a parking lane and sidewalk and filled with bioretention soil. Runoff from the roadway and adjacent buildings flows into the system for pollutant removal and tree growth.

*Based on a 1" (2.5 cm) storm event

Promenade (Vancouver, Canada)

Total soil volume per tree: 883 ft³ (25 m³)
 Total Silva Cells: 7,000 frames, 3,500 decks
 Installation type: Trees
 Client: City of Vancouver

This Vancouver promenade will be part of the Athletes' Village for the 2010 Olympic Games. The use of the Silva Cell to realize thriving and long-lived promenade trees will help showcase Vancouver's focus on green technology.

Streetscape (Tasmania, Australia)

Total soil volume per tree: 388 ft³ (11 m³)
 Total Silva Cells: 75 frames, 25 decks
 Installation type: Trees (retrofit)
 Client: Port Arthur Historical Site

A retrofit process enabled the Silva Cells to protect and enhance the growing medium for these heritage trees planted around 1835.

Streetscape (Amersfoort, Netherlands)

Total soil volume per tree: 400 ft³ (11.3 m³)
 Total Silva Cells: 34 frames, 17 decks
 Installation type: Trees
 Client: Heijmans

A private company installed Silva Cells to grow large, healthy trees to beautify an outdoor plaza area intended for employee use and enjoyment.

Courtyard (Devonshire, United Kingdom)

Total soil volume per tree: 460 ft³ (13 m³)
 Total Silva Cells: 80 frames, 40 decks
 Installation type: Trees
 Client: Ritchie Landscape Design

Silva Cells were installed in a courtyard at the center of a commercial building to enhance its look and feel for patrons and the public.

 **PARKING LOTS**

Parking Lot (Lakeland, FL)

Total soil volume per tree: 1,000 ft³ (28 m³)
 Total Silva Cells: 1,600 frames, 800 decks
 Installation type: Trees

The trees in this "big box" retailer parking lot had suffered for years from compacted soils, leaving them dead or in serious decline. A recent store renovation with a sustainable initiative added large soil volumes in Silva Cells underneath the new parking lot.

 **GREEN ROOFS**

Green Roof (Vancouver, Canada)

Total soil volume per tree: 268 ft³ (7.6 m³)
 Total Silva Cells: 20 frames, 20 decks
 Installation type: Trees
 Client: Eckford and Associates

This rooftop balcony tree has access to added soil volumes with the Silva Cell, creating a unique playspace for children and a focal point for the space. As the tree grows it will provide shade and a park-like environment on this south-facing balcony.

 **BREAK-OUT ZONES**

Break-Out Zone (Richmond, Canada)

Total soil volume per tree: n/a
 Total Silva Cells: 30 frames, 30 decks
 Installation type: Trees
 Client: City of Richmond

Taking advantage of large soil volumes in nearby open planting areas, this playground project used the Silva Cell as a bridge to help tree roots "break-out" of the immediate planting zone and thereby significantly increase soil volume at low cost.

These are just a few of the Silva Cell installations that have been completed.

For more information on these or other installations, please contact us at info@deeproot.com or (415) 781-9700.

DEEPROOT SUPPORT SERVICES

A VISION FOR THE FUTURE



INTRODUCING DEEPROOT URBAN SOLUTIONS, PROFESSIONAL SUSTAINABILITY SERVICES.

We're proud to announce Deep Root Urban Solutions, our professional sustainability services team, providing specialized support to architects, landscape architects, engineers and others. We specialize in integrating soil, stormwater, and tree growth into your project.

Green infrastructure and sustainability goals are of increasing importance, and achieving these goals requires technical understanding and training in varied fields. We offer time savings on your project by contributing specialty services to help meet your project goals. Peter MacDonagh, ASLA,

CSLA, is the Director of Science + Design for the Urban Solutions team. He heads a team of specialists including hydrologists, water resource engineers, tree and soil design specialists, and LEED-accredited professionals, all trained in green infrastructure. We deliver the most ecological and economical return to your site possible.

Please contact us for a proposal or presentation.

Peter MacDonagh (ASLA, CSLA, RHS, ISA) is the author of the "Site and Water" portion of the State of Minnesota's Sustainable Building Guidelines (B3) and completed the award winning Minnesota Soil Bioengineering Handbook for the Minnesota Department of Transportation. He is a Landscape Architect, Horticulturist and Arborist, and serves as an Adjunct Professor at the University of Minnesota.

THE FOLLOWING IS A PARTIAL LIST OF SERVICES. PLEASE LET US KNOW WHAT YOUR NEEDS ARE IF YOU DON'T SEE WHAT YOU'RE LOOKING FOR HERE.

Plans and Details

- Analysis of site plan and site details for efficient Silva Cell use, recommendations
- Analysis of existing Silva Cell layout plan, potential conflicts, recommendations
- Silva Cell layout plan from schematic design to construction documents
- Soil volume and Silva Cell calculations, including economic review of alternatives

Stormwater Design

- Analysis of site plan, site details, pavement details, for efficient Silva Cell use
- Calculations and stormwater modeling based on project components and infrastructure
- Silva Cell system design and layout from schematic design to construction documents
- Construction services (observation, inspection)
- Post Installation Evaluation (PIE) and long-term system evaluation
- Regulatory compliance, NPDES Phase II
- Total Maximum Daily Load (TMDL) Feasibility and Analysis

Tree and Soil Design

- Existing soil and drainage studies
- Planting space and planting soil design
- Tree size/soil volume calculations
- Construction services (observation, inspection)
- Species selection

Shop Drawings

- Independent desktop review of project construction support documents relating to Silva Cell design as requested by the contractor
- Custom, site-specific layout and detailing of Silva Cells, based on project construction documents, for contractor installation

Training

- Contractor training and workshops (in-house and remote)
- Professional training and workshops (in-house and remote)
- Complimentary lunch and learn opportunities, group presentations

NOTE: All Silva Cell layouts and details shall be reviewed and approved by project engineer. Please contact us for more information and to discuss the specifics of your project needs.