

Culver City Residential Parkway Guidelines

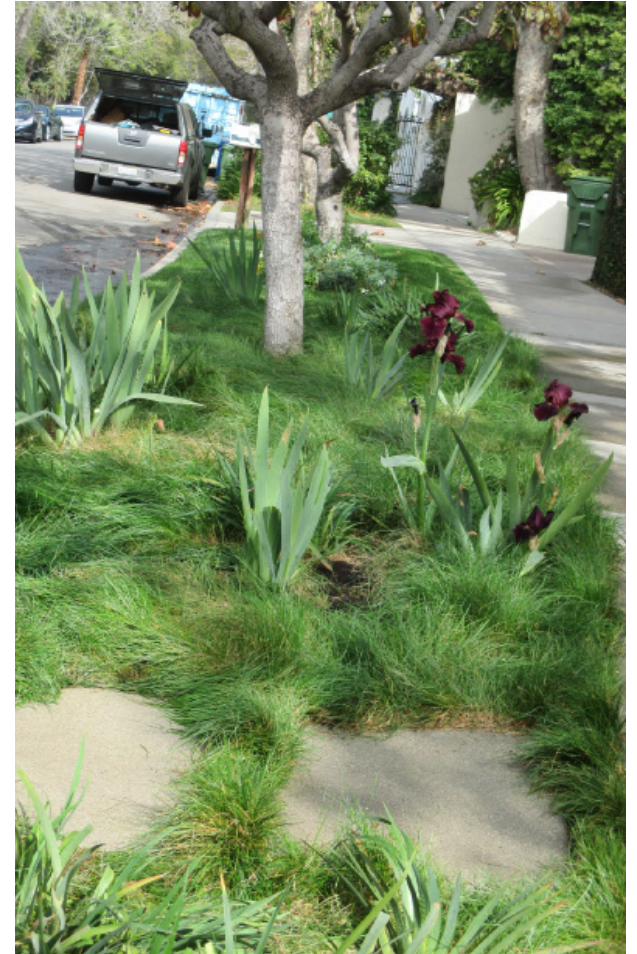

Culver City, California
2016

residential parkway guideline team

CITY OF CULVER CITY

DEPARTMENT OF PUBLIC WORKS

Charles D. Herbertson, Public Works Director / City Engineer

Joe Susca, Senior Management Analyst

Eric Mirzaian, Maintenance Operations Manager

DEPARTMENT OF PARKS, RECREATION, AND COMMUNITY SERVICES

Patrick Reynolds, RLA, Parks Manager

CITY MANAGER

John Nachbar

CURRENT AND FORMER CITY COUNCIL

Micheál O'Leary, Andrew Weissman, Jim B. Clarke, Jeffrey Cooper, Meghan Sahli-Wells,

Thomas Aujero Small, Göran Eriksson

CONSULTANT TEAM

ARTECHO ARCHITECTURE + LANDSCAPE ARCHITECTURE

Pamela Palmer, ASLA

Sonia Brenner

Catherine Burce

INTRODUCTION	7
1 What is a Parkway?	
2 Why are Parkways Important?	
3 How to Use this Booklet	
RESIDENTIAL PARKWAY STANDARDS	9
1 Planting (includes maintenance + irrigation)	
2 Hardscape + Access	
3 Objects	
HOW-TO GUIDE	15
1 Planning	
2 Installation	
3 Maintenance (includes watering)	
SCHEMATIC DESIGNS + PLANT PALETTES	23
1 Culver City Native Garden	
2 Tried-and-True California Natives	
3 More Tried-and-True Plants for Southern California	
4 Low Water Lawn / Meadow	
5 Edible Garden	
SPECIAL TOPIC: RAIN GARDENS	34
ADDITIONAL PLANT LISTS	37
1 Plants for under Native Oaks	
2 Plants for under Eucalyptus (or other large tree)	
3 Succulents	
4 Plants for Shade	
5 Prohibited Plants	
PARKWAY EXAMPLES	43
RESOURCES	45

vision + goals

These Parkway Guidelines support Culver City's commitment to shaping a vibrant, healthy, and sustainable urban environment.

The goal of the Parkway Guidelines is to support the creation and maintenance of parkways in Culver City that are safe, accessible, resource-efficient, ecologically responsible, beautiful, and that preserve the health of City trees.

introduction

what is a parkway?

A parkway is defined as the portion of a public street right-of-way lying between the curb and sidewalk (see diagram below). It is sometimes referred to by other names such as sidewalk strip, parking strip, or tree buffer. In residential areas, the parkway is usually a long planting strip, broken up by driveways. On commercial streets planting is often restricted to smaller “tree wells.” These guidelines specifically address parkways in residential areas.

Trees that are located in the parkway are owned and maintained by the City. However, it is the responsibility of property owners to maintain the rest of the parkway in good condition.

why is it important?

The trees and plants in the parkway provide significant environmental, social, and economic benefits for residents, workers, and visitors to Culver City. Parkway help to shape our everyday environment and the identity of our community; they are an extension of each residence’s landscape as well as the larger streetscape. Parkway can also provide important urban habitat for pollinators, birds, and butterflies. While each individual parkway may seem small, if we were to consider the total area of all the parkways in the City, we can appreciate that these spaces are an important part of our urban environment.

The parkways are an important component of the urban forest, defined as the ecosystem of plants and people in the City. The urban forest, in turn, is a valuable “green infrastructure” - a landscape system that provides important ecological services to the City such as cooling, stormwater runoff reduction, and energy use reduction.

how to use this book

These guidelines are intended to inform residents of Culver City about residential parkway regulations and to assist them in planning, creating, and maintaining a parkway landscape.

These guidelines explain what is (and is not) allowed in residential parkways, describes situations where a permit is required, and addresses questions of maintenance and responsibility. Five schematic designs with plants lists, as well as additional plant lists, are provided to assist residents with making a plan to fit their goals and the site conditions. At the end of the guidelines is a list of contacts and sources for further information.

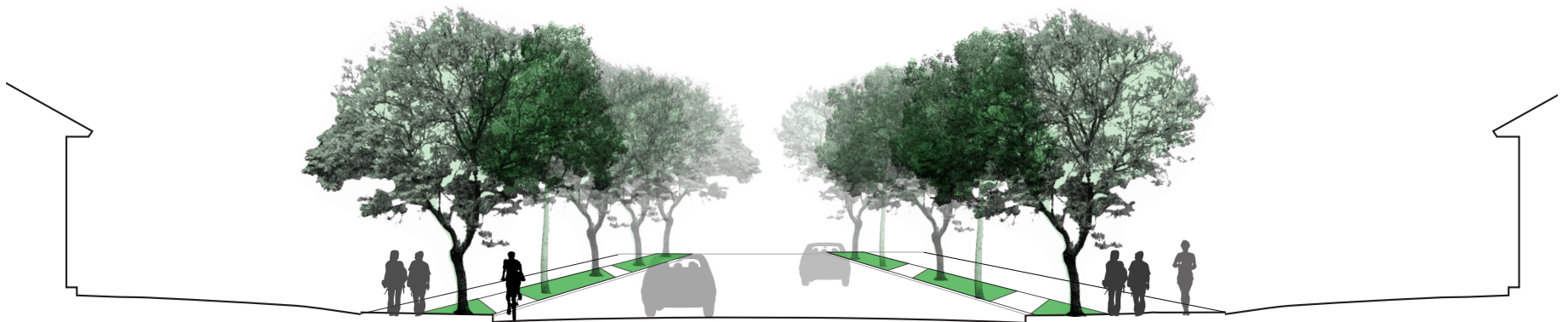

residential parkway standards

The following standards apply to all changes made to residential parkways in the City.

parkway standards at a glance

RESPONSIBILITY

- It is the responsibility of the adjacent property owner to maintain all plantings (except for the street tree) and other items in the parkway, including watering, as necessary
- Any objects placed in the parkway (e.g. rocks, benches) must not present a hazard or public nuisance and must be lower than 30" to ensure a clear line of sight across the parkway (**with the exception of a small library, which may not exceed 5' in height**)
- The City is not responsible for any property damage, personal injury, or theft of plants or objects placed in the parkway

PLANTING

- All new plants shall be water-efficient and climate-appropriate, that is, plants that can survive in Culver City with moderate to low supplemental irrigation or none at all
- Plants with thorns, spines, or burs are not allowed; nor are poisonous plants
- Conventional turf is not allowed, nor is artificial turf
- Edible plants are allowed adjacent to multi-family dwellings only. If a resident of a single-family home does not have suitable space for edibles in their yard, however, they may apply for an exemption.
- A 2-3" layer of mulch is required for all planted areas (except for areas covered by groundcover). Keep mulch several inches away from the base of plants and 12" from the base of tree trunks, to reduce the risk of rot
- Within 5' of a driveway, plants must be kept under 24" in height; elsewhere in the parkway, they must be kept under 30" in height.
- At least 75% of the parkway area must be permeable. Planting should cover 50% of the parkway (based on mature size of plants, not size at installation)

HARDSCAPE + ACCESS

- Any hardscape must not pose a tripping hazard
- A step-out strip must be provided along the length of the curb to allow passengers to access their vehicles. The step-out-strip is to extend at least 18" from the back of the curb. In addition, one path (accessway) across the width of the parkway (from the curb to the sidewalk) is required per standard parcel. The step-out strip and accessway are to be a uniform walking surface (hardscape or walkable groundcover plants)

Please note that the images included in the guidelines are included as examples. However, in some cases they do not perfectly adhere to the guidelines.

For the Culver City Municipal Code related to parkways, please refer to § 9.08.700 "Parkway Landscaping." <http://www.culvercity.org/city-hall/information/city-charter-municipal-codes>

BEFORE YOU DIG, remember to call Dig Alert at 800-422-4133 to locate buried utility lines.

PLANT AREA + LAYOUT

At least 75% of the parkway area must be permeable (allow water to pass through) and planting should cover 50% of the parkway (based on the mature size of plants, not their size at installation).

For the health of the street trees, plantings shall be a minimum of 12" away from tree trunks (24" recommended) and shall not negatively impact the existing tree root systems.

PLANT TYPE

All new plants shall be water-efficient and climate-appropriate, that is, plants that can survive in Culver City with moderate to low supplemental irrigation or none at all. Plants that require a high amount of irrigation are not allowed.

No invasive species are allowed. For the purposes of these guidelines, "invasive species" includes any plant on the current list of the California Invasive Plant Council's "Don't Plant a Pest" program (Southern California region) OR in the Plant Right program's invasive list for the South Coast region. See the "Prohibited Plants" list and the Resources page for more information on invasive species.

In order to prevent potential hazards or public nuisances, the following are not allowed: plants with thorns, spines, burs, poisonous plants*, and ivy or other dense groundcovers that might harbor rodents. In order to increase habitat value and permeability, artificial turf is not allowed.

TREE PROTECTION

When installing new plants, hardscape, or a bench in the parkway where there is an existing tree, it is important to dig carefully, by hand, in order to minimize damage to the tree roots. It is best to not cut any tree roots, but if you believe it may be necessary for your project, first contact the Urban Forester at (310) 253-6420 for guidance. The cutting of roots should be performed by a certified tree worker or licensed arborist. No roots over 2" in diameter shall be cut. If there are a lot of large roots in the parkway, you may have to plant around them and may want to select plants that are small - both in terms of size at planting and size at maturity. Smaller plants will be easier to plant and they will generally need less space for their root systems. For the complete standards regarding root pruning in the parkway, please refer to Appendix J of the Culver City Urban Forest Master Plan.

Where there is an existing street tree, the finish grade (the soil level) should not be altered (neither raised nor lowered) as this can significantly damage the tree roots and trunk and can lead to overall decline of the tree.

PLANT HEIGHT

In order to preserve a clear line of sight across the parkway, plants must be kept under 30" in height. Within 5' of a driveway, plants must be kept under 24" in height. Trees are excluded from this height limit.

*Some helpful online resources on poisonous plants include lists from Colorado State University, Cornell University, and the ASPCA.

EDIBLE PLANTS

Edible plants in the parkway present several potential problems: these plants generally need a lot of water, they tend to be too tall for the parkway, and fruit and vegetables can fall on the street and sidewalk.

Residents of multi-family dwellings are permitted to plant edibles in the parkway provided that they select and maintain the plants as outlined in these guidelines. Residents of single-family dwelling typically have other, more suitable space in which to grow edibles; as such, edible plants (fruits, vegetables, herbs, greens, etc) are prohibited in the parkway adjacent to single family dwellings. If a resident of a single-family dwelling does NOT have suitable space for edibles in their yard, they may apply for a permit to plant edibles in the parkway; they should include photos that clearly document the situation.

Fruits and vegetables grown in the parkway will be considered part of the public domain; the adjacent property owner does not have exclusive claim to them. The installation of any barrier to prevent harvesting will not be permitted. Please refer to the schematic design and list of edible plants.

Fruit trees in parkways will be considered by permit only, and only where there is sufficient growing space and the tree would not take up the space that would otherwise be occupied by a City street tree. The homeowners would be solely responsible for maintenance and any liability associated with the tree as memorialized in an agreement with the City.

The following standards apply to fruit trees:

- Only dwarf or semi-dwarf size fruit trees are allowed. In general, dwarf fruit trees grow to 8-10' tall and wide, and semi-dwarf trees grow to 12-15' tall and wide. These smaller sizes are more suitable to parkways; in addition, fruit may be harvested without the need for a ladder
- It is recommended that a fruit tree be located at least 10' from a driveway approach, at least 10' from a light pole, and at least 5' from utility boxes. Additional restrictions may apply for a corner lot. Staff will review this during plan check in order to determine the best location in each case
- It is important to maintain line of sight across the parkway for safety. This will be a primary consideration during the permit review. It is recommended that once the tree has grown to a sufficient height, that lower limbs be removed as appropriate to maintain the line of sight across the parkway
- Refer to Diagram 1 for planting detail

Fruit trees should be planted in well-draining soil in full sun with some shelter from wind. Different types of fruit trees have specific needs in terms of fertilizer, pest management, pruning, and soil pH level. Check the pH level and select a fruit tree that can thrive in that soil condition. To select a fruit tree variety that can grow well in Culver City, check with a local nursery or refer to the *Sunset Western Garden Book*.

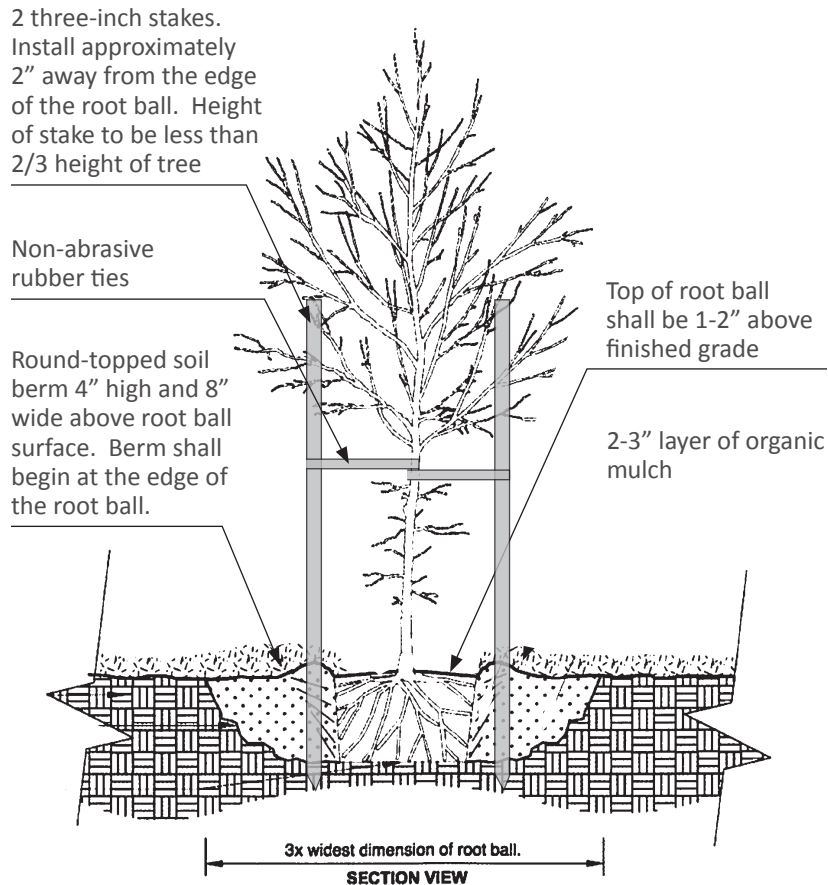

Note: perform this test to see if the stake can be removed: move the trunk of the tree and watch for movement of the root ball. If the root ball does not move, the stakes may be removed

Diagram 1. Detail for tree planting showing berm for water retention

MAINTENANCE

It is the responsibility of the adjacent property owner to maintain all plantings (except trees*) and other items in the parkway, including watering, as necessary. The property owner is responsible and liable for ensuring that the parkway is kept in a clean and neat condition and free from objectionable matter and from encroachments or obstacles which may pose a hazard to persons or property, including tripping hazards. Maintenance of the parkway landscape is at the expense of the property owner.

A 2-3" layer of organic mulch (composed of bark, wood, and/or composted leaves) is required for all planted areas (except for areas covered with groundcover). Keep mulch several inches away from the stem of a plant and 12" from a tree trunk to reduce the risk of rot.

Plants should be maintained so that they do not overhang the step-out strip, accessway, sidewalk, or curb, so as not to impede access across the parkway.

IRRIGATION

Parkways should be irrigated with either low-volume drip systems or by hand-watering. Irrigation water must not run off outside the parkway area. The installation of spray irrigation systems in residential parkways is not permitted, because of its tendency to overspray onto hardscape. An existing spray system may remain in place.

The installation or modification of an irrigation system in the parkway requires a permit. Drip irrigation systems should be installed according to the manufacturer's specifications. During the plan check, City staff will confirm that the irrigation system design adheres to all California Building and Safety, Plumbing, and Health codes.

See p. 20-21 for more information on watering plants and trees in the parkway. For parkways that are part of a larger landscape rehabilitation or new development, please refer to the irrigation requirements in the current version of the state Model Water Efficient Landscape Ordinance (MWELO) and AB 1881.

* Trees in the parkway are owned and maintained by the City, with the exception of fruit trees that are allowed by these Guidelines.

ACCESS / CIRCULATION

To allow pedestrian movement across the parkway, a step-out strip along the length of the curb shall be provided to allow passengers to enter and exit their vehicles (See Diagram 1 + photo below). A step-out strip is not required where tree roots preclude such a strip or where there is a red curb. The strip can be interrupted where there is a fire hydrant.

The strip must be a uniform, firm walking surface, such as walkable ground cover, organic mulch, or paving (see Paving Materials), extending at least 18" from the back of the curb. Plantings shall not encroach on the step-out strip or the sidewalk, nor hang over the curb into the street.

In addition, one unimpeded path (accessway) from the curb to the sidewalk is required per standard parcel, preferably located where car doors open. Additional accessways may be required for large parcels at the discretion of the Public Works Director / City Engineer. The accessway is to be a minimum of 24" wide. Like the step-out strip, the accessway must be a uniform, firm walking surface (such as walkable ground cover or paving (see Diagram 2 + photo below). Note that if most or all of the parkway is planted in a walkable ground cover, the step-out strip and accessway may not appear distinct from the rest of the walkable planting (see the schematic design for Low-Water Lawn / Meadow). The homeowner may want to select the best location for the accessway by observing where cars usually park and where people tend to cross the parkway, although this is not a requirement.

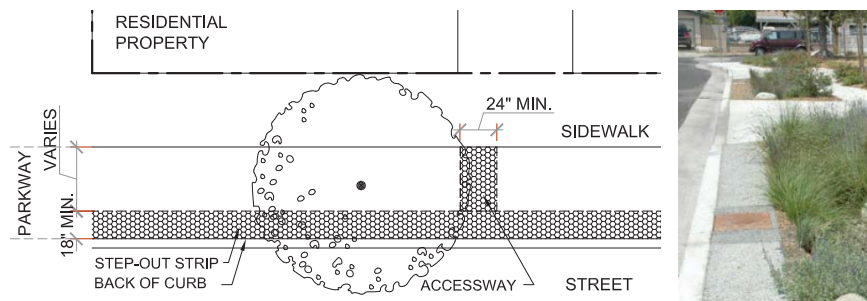

Diagram 2. Required step-out strip and accessway. The photo shows a gravel step-out strip. Note that either paving material or plants can be used for the step-out strip and accessway, as long as they form a uniform, firm walking surface.

PAVING MATERIALS

Any paving materials must be maintained flush with the ground, back of curb, and edge of sidewalk so as not to pose a tripping hazard. Any loose paving materials must be contained within the parkway and not spill onto the street or sidewalk.

At least 75% of the parkway area must be permeable (allow water to pass through) - either permeable paving, plants, mulch, or a combination of these. 50% of the parkway area must be planted.

Acceptable permeable paving includes non-stabilized decomposed granite (DG), angled gravel that “locks” in place (smooth gravel is not allowed because it is slippery to walk on and can spill onto the sidewalk), and permeable pavers (pavers designed with joints that allow water to pass through).

Impermeable paving (including stabilized DG, brick, concrete, concrete pavers, and stone pavers) is allowed in the parkway if the minimum planting area and other requirements are met. Where feasible, impermeable surfaces should be graded as appropriate to direct storm water runoff into the permeable areas of the parkway. If possible, set impermeable pavers on sand so that water can pass through the joints. Bricks, flagstone, and concrete can usually be set this way to create a uniform, firm walking surface. Follow manufacturer’s specifications.

To preserve the health of existing trees, impermeable paving is allowed under the dripline (canopy) of a tree only for the accessway and step-out strip. Any paving should be located at a minimum of 3' from the trunk, if it can be done without disturbing tree roots. If possible, it is better to locate paving beyond the dripline of the tree to minimize root disturbance and maximize the space where water can penetrate the soil. If you are installing paving near tree roots, it is important to select a paving material and installation method that will disturb the roots as little as possible and which will allow for future growth.

3 objects in the parkway

If your design for the parkway includes a bench, small library, or other objects, a no-fee permit application is required (see pages 16-17 regarding permit applications). When City Staff reviews your application, they will take into consideration the overall layout of the parkway as it relates to the proposed object(s) in order to best maintain visibility and access across the parkway.

Once the homeowner receives the approved permit and installs the object in the parkway, the homeowner is responsible for maintaining the object in clean and safe condition so that it does not pose a hazard to persons or property. The City is not liable for accidents that occur from an object placed in the parkway.

BENCHES

A parkway must be a minimum of 5'-6" wide in order to accommodate a bench. This width accounts for the required 18" wide step-out strip as well as a 48" long (by 30" wide) wheelchair access area directly adjacent to the bench, which allows a person in a wheelchair to pull up next to the bench. The bench must be set back from the back of curb a minimum of 18", it also must be set back from the sidewalk a minimum of 18" (see Diagram 3).

The bench must be anchored into the ground to keep it in place and stable. If the bench is made of wood, the wood must be stained or painted. Footings should be located more than 3' from base of tree, and if possible, beyond the dripline (canopy) of the tree.

The top of the bench back must not exceed 30" tall, to allow for clear sight lines across the parkway. The maximum length for any bench in the parkway is 6' (72"), to limit impediments to movement across the parkway. The bench may face either the sidewalk or the street.

In addition to the no-fee permit, a maintenance covenant must be signed, which indicates that the adjacent property owner (and future owners) accept responsibility for maintaining the bench.

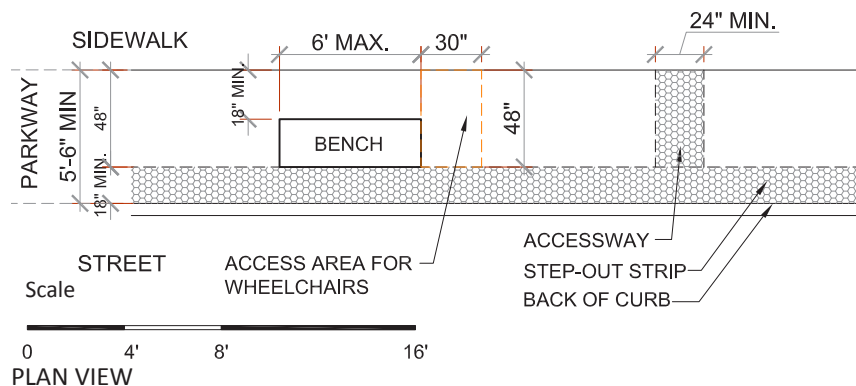

Diagram 3. Required dimensions for installing a bench in the parkway

SMALL LIBRARY

Similar in size and shape to a bird or doll house, a small library allows neighbors and passers-by to connect with each other through a free exchange of books.

A small library shall not be located in, nor project into, the step-out strip, nor shall it project over the curb or sidewalk. To preserve a clear line of sight, the library shall be located more than 5' from the closest point on the driveway. When you apply for the no-fee permit, be sure to indicate the proposed library location on your plan drawing; in addition, include a drawing of the proposed lending library showing all dimensions.

The library shall be installed on a sturdy post with a concrete footing to keep it stable and upright. The height of library (when mounted on the post) shall not exceed 5'. In order to preserve access and visibility, the size of small libraries is limited to a maximum of 3 cubic feet in volume (height, width, and depth may vary). Glass is not permitted.

OTHER OBJECTS

The City does not encourage the placement of other objects (e.g. statues, rocks) in the parkway because these limit access across the parkway. All plants and objects in the parkway must be kept under 30" tall in order to preserve a clear line of sight across the parkway. Any objects in the parkway must not present a hazard or public nuisance.

ADDITIONAL NOTES

In the case of a corner lot with two parkways, each parkway will be required to adhere to these guidelines (including relative proportions of hardscape and planted area) independently of the other.

Any changes to the parkway should be designed and implemented in such a way as to preserve the health and stability of existing street trees.

The edges of the parkway should be flush with adjacent hardscape (including curb, sidewalk, and driveway apron).

1 PLANNING

- How to Get Started
- How to Apply for a Parkway Permit
- How to Select Plants

2 INSTALLATION

- How to Remove Turf
- How to Prepare for Planting
- How to Purchase Plants (seed, sod, size, etc.)
- How to Plant

3 MAINTENANCE

- How to Maintain your Parkway
- How to Water your Parkway

how to get started

This booklet can help you with most or all of your needs to plan any changes in the parkway in front of your home. If you do not find the answer to your questions here, please contact the Engineering Division at 310-253-5600.

1. Define your goals and priorities

Consider what is most important to you about the parkway. Do you want it to be a continuation of your front yard landscape? To provide year-round beauty? To provide habitat? Be low-maintenance? These priorities will guide your decisions and shape the plan.

2. Observe and measure the site conditions

Look at the conditions of sun and shade over time. Examine the soil to determine whether it is fast or slow-draining, and whether it is sandy, loamy, clay, or in between (you might do a simple texture test, percolation test, or use a pH test kit). Look at the tree in the parkway and try to identify it*; notice its age, size, and location of roots. Measure the dimensions of the parkway so that you can get accurate quantities of the plants and hardscape materials you have selected.

3. Make a plan and review the Parkway Standards and Guidelines

Review the schematic plans and plant palettes included here to help you create a plan that fits your goals, priorities, and site conditions. You may find it helpful to draw a plan to scale using graph paper. Re-read the standards to make sure that your plan is in compliance.

4. If necessary, apply for a permit

See the following section, “How to Apply for a Permit,” for more information.

BEFORE YOU DIG, remember to call Dig Alert at 800-422-4133 to locate buried utility lines.

* For help identifying the parkway tree, refer to the Tree Designations section in the Culver City Urban Forest Master Plan and/or the Tree Map LA website

how to apply for a permit

If you are adopting one of the five schematic designs, and if your plan does not depart from the plant palettes and other standards, the City does not require a permit.

Designs that include 1) a rain garden or 2) a new or modified irrigation system require a permit with a fee.

Designs that include 1) a bench, 2) a fruit tree, or 3) other objects, require a no-fee permit (a permit that is issued free of charge). Designs that include a fruit tree must also sign a separate Fruit Tree Planting Agreement when the permit is issued. You may also elect to obtain a no-fee permit if you want confirmation that your plan complies with these standards.

To apply for a permit, first read and complete the permit application (see following page). Attach a labeled plan drawing of the proposed changes to the parkway, showing the location of all existing street trees, fire hydrants, etc. and any proposed changes, along with the relevant dimensions (please refer to the plan drawings of the schematic designs as examples). Also, attach specification sheets for each proposed material or planting. Bring the application, plan drawing, and any supporting materials to the Engineering Division of Public Works in City Hall for review during open hours.

Note that the permit application requires the signature of the property owner or Authorized Agent (for example, a property management firm hired by the property owner). If a renter is able to demonstrate that their lease authorizes them to alter the parkway, or has a letter of authorization from the property owner, then a renter may apply for the permit.

how to select plants

Keeping in mind your goals, priorities, and site conditions, review the plant lists and schematic designs here to select a palette of plants. These plant lists are based on extensive research and experience to make it easier for you to select plants for the parkway. Remember a few key principles:

1. Consider the parkway tree. Certain trees, especially if they are mature, might influence which plants you choose. See the plant lists for more information.
2. Consider sun, shade, and soil conditions in your parkway, and select plants that work best with the site conditions. Select plants with similar water requirements-- it will be more efficient to irrigate the entire parkway the same amount.
3. Keep it simple by choosing a limited number of different plants that work well together. This will create a more unified look and will make it easier to maintain your parkway. Grouping plant types in odd numbers (i.e., groups of 3 or 5) helps create a layout that is pleasing to the eye.



PUBLIC WORKS DEPARTMENT
 9770 CULVER BOULEVARD, 2ND FLOOR
 CULVER CITY, CALIFORNIA 90232-0507



MATE GASPAR

Engineering Services Manager
 Engineering Division

Phone (310) 253-5600
 FAX (310) 253-5626

RESIDENTIAL PARKWAY LANDSCAPING PERMIT APPLICATION

Property Owner (Required)

Name _____
 Mailing Address _____
 City/Zip _____
 Phone Number _____
 Email Address _____

List proposed plant species:

Tenant (if applicable) _____
 Address _____
 Phone Number _____
 Email Address _____

List any other proposed changes to the parkway:

Contractor (if applicable) _____
 Address _____
 City/Zip _____
 Phone Number _____
 State License Number _____
 City Business License Number _____

Property Owner or Authorized Agent signature _____ Date: _____
 Approved by _____ Date: _____
 No Fee Permit _____ Standard Fee Permit _____ Requires Inspection _____

- The City is not responsible for any property damage, theft, or personal injury from plants or objects placed in the parkway.
- If you are adopting one of the five schematic designs, and if your plan does not depart from the plant palettes and other standards in the Residential Parkway Guidelines, the City does not require a permit. Designs that include 1) a rain garden or 2) a new or modified irrigation system require a permit with a fee. Designs that include 1) a bench, 2) a fruit tree, or 3) other objects, require a no-fee permit (a permit that is issued free of charge). Designs that include a fruit tree must also sign a separate *Fruit Tree Planting Agreement* when the permit is issued.
- You may also elect to obtain a no-fee permit if you want confirmation that your plan complies with the standards.
- Fees are adopted annually by City Council Resolution. Technology surcharge of 4% applies to all fees.
- Attach a labeled drawing of the proposed changes to the parkway, showing the location of all existing street trees, fire hydrants, etc. and any proposed changes, along with the relevant dimensions. Also, attach specification sheets for each proposed material or planting.
- Notwithstanding whether changes to the parkway have been permitted, if the City determines that it must remove or alter the landscaping at a later date to conduct maintenance, capital improvements, or other governmental purposes, the City shall not be responsible for replacing the landscaping. The property owner shall be allowed to replace the landscaping at his/her own expense under the original permit, as long as it still meets the City's requirements. As practicable, the City will work with the property owner to preserve the plants that are being removed for possible replanting at the conclusion of the project or for reuse by the property owner at another location.
- Proposed changes to the parkway must comply with CCMC §9.08.700 and the Residential Parkway Guidelines approved by City Council Resolution.
- City-owned tree removals/plantings require a separate application and must be approved by the Maintenance Operations Division, (310) 253-6420.
- For all other questions, please contact the Engineering Division at (310) 253-5600.

2 INSTALLATION

how to remove turf

BEFORE YOU DIG, remember to call Dig Alert at 800-422-4133 to locate buried utility lines.

General instructions:

1. Water the area with turf three days before to make the soil easier to manage. The soil should be moist but not soggy.
2. Remove the turf with hand tools. Do not use motorized tools or machines as their use will likely damage the tree's roots. Please refer to the section on Tree Protection on p.10.
3. During the removal process, excavated turf and soil shall be placed onto an impermeable surface like a plastic or cardboard sheet, and not onto soil, where grass seeds and roots could spread. Excavated turf and soil can then be moved into the green bins.
4. Usually, soil must be added after turf removal to bring the grade up to the original level. Add soil immediately after turf removal as needed to cover exposed tree roots to prevent sun damage or mechanical injury.

If there is an existing parkway tree, it is important to follow these turf removal instructions carefully to protect the tree roots:

All excavation under the dripline (the area under the canopy of the tree) of any tree shall be done manually with hand tools, such as a flat-edge spade (a professional arborist may also use a special tool called an Air Spade®).

Use the flat edge spade to slice just under the grass, then pull the turf back while severing the roots of the grass just below the soil line. Cut the turf into parallel strips using an edger or sharp spade (with square edge). Be sure to keep strip sizes small and manageable, approximately 1' wide by 2' long. Shake off excess topsoil during this process.

If there is no existing parkway tree, you could use other hand tools (i.e. shovel, pickaxe, or sod lifter). You may want to consider solarizing the turf (covering it in clear plastic during the summer, for about 3 months). This process requires less labor and no herbicides, but does require sufficient heat and time, and uses plastic.

how to prepare for planting

BEFORE YOU DIG, remember to call Dig Alert at 800-422-4133 to locate buried utility lines.

Remove as many weeds as possible. If you removed turf, look for any turf grass re-emerging, and remove the entire plant with roots. By removing weeds now, you will have less weeding to do once the plants are in the ground.

Based on the results of your soil analysis (see "How to get Started," p.16) and the soil needs of the plants you have selected, incorporate any necessary amendments into the soil now, before planting.

If installing irrigation, it is easiest to install now, before planting. Review the Irrigation section in the previous chapter.

how to purchase plants

At the nursery, select healthy plants. Selecting small container sizes (e.g. 1 gallon size, or 5 gallon for a few larger shrubs) will help you to save money. Smaller, young plants are often better able to adapt to transplanting and often they quickly "catch up" in size to plants that were purchased in larger container sizes.

Consider purchasing odd numbers of each plant type (like 3, 5, 11). Grouping odd numbers of plants helps to create a layout that is pleasing to the eye.

how to plant

BEFORE YOU DIG, remember to call Dig Alert: 800-422-4133.

1. Lay out the plants, in their containers, in the parkway, until you find a pleasing layout. Keep in mind the ultimate width of the plants - this will determine the proper spacing of plants. Planting too close together can cause the plants to grow awkwardly and can lead to disease in some species. Planting too far apart will leave gaps, but those could be filled in later. You may choose to temporarily fill the empty space left for a woody shrub with annuals or perennials, which could be removed when the shrub expands.

2. Dig holes that are just slightly shallower than the containers, so that when you place the plant in the ground, the crown (where the stem/trunk emerges from the soil) will sit just slightly above the surrounding soil. This allows for the soil to settle. It is better for the plant to sit slightly higher than the surrounding soil than below the level of the surrounding soil. Ideally, you want to keep the piles of excavated soil free from mulch, so that when you replace the soil, you are not putting mulch into the planting hole. When buried in the soil, mulch can remove nutrients from the soil when it breaks down. Please refer to the section on Tree Protection on p.10.

3. Water the container plants and the planting holes so that they are moist, but not sopping wet. This will help reduce the shock of transplanting.

TIME OF PLANTING

The best time to plant in Southern California is the fall, because the plants will benefit from the rainy season and will start to develop roots before the heat of summer. Winter and early spring are also good times to plant. Planting in summer is not recommended because it will be more difficult for the plants to survive the hot, dry season, and they will require more water to do so. Some grasses, such as those included on the Low Water Lawn / Meadow palette, should be planted at certain times of year - refer to the palette for more information.

After purchasing plants and before planting them, do not let them sit too long in the hot sun - they can quickly dry out. It is better to place them in the shade before planting. If possible, plant during the cooler times of day, rather than during the hottest time of the afternoon.

4. To remove the plant from the container, first squeeze all around the container to free the rootball from the sides of the container. Do not pull the plant out by the branches or stems. Instead, put your hand near the base of the plant, then carefully invert the container so the rootball slides out into your hands.

5. Observe the rootball of the plant. If you see roots encircling the rootball, untangle them - if left as is, these roots could eventually damage the plant. You want these roots to go outward, into the soil, rather than circle around the plant. Using your finger, gently scratch lines from the top to bottom of the rootball to loosen the fine roots. This will encourage the roots to extend beyond the shape they had in the container.

5. Place the plant into the planting hole so that the base of the plant is slightly above the surrounding soil level. Push the soil down gently to remove any air pockets.

7. Water the plant well.

8. After all the plants are in the ground, apply a 2-3" layer of mulch to preserve moisture and improve soil health. Keep mulch several inches away from the plant stems and 12" away from tree trunks. If mulch covers the stem/trunk, the plant has less access to air, which increases the risk of decay.

how to maintain the parkway

It is the responsibility of the property owner to maintain the parkway in front of their house, including all plantings and other items in the parkway, including watering, as necessary. The property owner is responsible and liable for ensuring that the parkway is kept in a clean and neat condition and free from objectionable matter and from encroachments or obstacles which may pose a hazard to persons or property, including tripping hazards. Maintenance of the parkway landscape is at the expense of the property owner.

A 2-3" layer of organic mulch (composed of bark, wood, and/or composted leaves) is required for all planted areas (except for areas covered with groundcover). Organic mulch reduces weeds, preserves soil moisture, and, as it breaks down, improves the structure and biology of the soil. Inorganic mulch (e.g., gravel or stones) can limit gas exchange at the roots, which is essential to the tree's health. Redwood mulch is discouraged because it does not readily break down, so it has limited value in improving the soil quality. Keep mulch several inches away from plant stems and 12" away from tree trunks to reduce the risk of rot.

Different plants have different maintenance needs. For example, some plants do best if pruned or fertilized at a certain time of year. Keep it simple by selecting just a few plants for your parkway and learning the maintenance needs of each (see the Resources section for websites and books for more information about the plants' maintenance needs). The plants included in the plant palettes and lists here are relatively low-maintenance compared to other plants. For plants that benefit from fertilizers, the use of organic fertilizers is encouraged.

Plants should be maintained so that they do not overhang the step-out strip, accessway, sidewalk, or curb, so as not to impede access across the parkway.

how to water the parkway

(Note: for information about watering parkway TREES, see next page)

- Please refer to the Irrigation section on p.11 for standards regarding irrigation.
- The plants included here all require low to moderate irrigation, with the exception of edible plants, which usually require regular irrigation.
- The most important part of watering plants is to carefully observe the plant and soil, and make adjustments as needed. The amount you need to water depends on the type of plant, but also on your soil type, solar orientation, and changing conditions like weather and season. Refer to the Resources page for a useful online watering calculator.
- During a drought, residents must comply with current City watering restrictions, which are posted on the City's website.
- Plants need different amounts of water at different times. There are roughly 3 stages to keep in mind:
 1. Right After Planting (few days to a week)
Plants need more water to help them overcome the shock of transplanting. For a few days to a week after planting, be especially observant of the plant and soil. The soil should be consistently moist like a wrung-out sponge (but not wet), and the plant rootball and surrounding soil should not dry out completely.
 2. Establishment Phase (several months to a year)
A good rule of thumb is to hand water when the soil is dry about 3" below the surface, or to set your drip system timer to 3 times a week, 45 minutes each time. Infrequent, deep watering is more effective than frequent, shallow watering. Low-water and drought tolerant plants need a bit more water when they are young and developing their root systems.
 3. Established Plants
Many of the plants included here are drought-tolerant once they are established. Several months after planting, begin to decrease the frequency of irrigation, and carefully observe how the plants respond (some plants take longer to establish than others). Try setting your drip system at once a week from October through March, and twice a week from April through September. Especially during a drought, see if you can reduce irrigation without causing the plants to decline.
- Finally, keep in mind that many more plants die from over-watering than from under-watering!

how to care for a tree in the parkway

Trees that are located in the parkway (the portion of the street right-of-way between the curb and the sidewalk) are owned and maintained by the City. However, residents can also play an important role in keeping parkway trees healthy. This sheet offers a summary of key information about caring for “your” parkway tree.

WATERING

For the first year after a tree is planted, the City waters the tree periodically so that it can adapt to its new site and develop a healthy root system. After one year, the City waters only in case of prolonged drought, when the trees are at greatest risk of decline.

During drought, homeowners can provide supplemental irrigation to help sustain young and mature trees. As a rule of thumb, water trees 10G per 1” of trunk diameter (measured at 4.5’ above ground). For palms below 20’ tall, water 20G; for those above 20’, provide 50G. For trees with minimal water needs, watering (in the amount described above) twice a month from April to October should help reduce stress during drought years.

MULCH

Organic mulch (composed of bark, wood, and/or composted leaves) is very important for retaining moisture in the soil, improving the soil biology, and reducing weeds. A 2-3” layer of medium-texture organic mulch is recommended to cover an area of at least 4-5’ in diameter around the tree. It is important to keep mulch about 12” from the trunk-- when mulch is piled at the base of the tree, it creates conditions that favor decay, disease, and insect damage. The use of inorganic mulch (e.g., gravel or stones) is discouraged around trees because it can limit gas exchange at the roots, which is essential to the tree’s health.

STAKES

When the City plants a tree in the parkway, they use stakes to stabilize the tree and help it to grow a straight trunk. The City will remove the stakes when they are no longer needed. Please do not remove the stakes yourself.

PROBLEMS OR QUESTIONS?

If you have a general question about the characteristics and maintenance requirements of the tree in your parkway, please refer to the CalPoly Selectree website (<http://selectree.calpoly.edu/>) for detailed information.

If you think there is a problem with a parkway tree (you notice fungus on the trunk or roots, dead limbs, leaves yellowing or falling out of season, damage or wounds, etc.), or if tree roots are damaging the sidewalk, please contact the Maintenance Operations Division at 310-253-6420 or 310-253-6440.

KEY FACTS ABOUT TREE ROOTS:

- A tree’s root mass is its foundation and provides the structural support it needs to remain standing upright. Over-watering can damage this foundation and can affect tree stability.
- Most, if not all, of a tree’s roots are found in the upper two feet of the soil surface.
- The roots of a street tree can extend up to four times the diameter of its canopy, which places much of the root mass in a front yard landscape. Regularly watering a front yard landscape (discourages) deep rooting.
- Deep and/or infrequent watering encourages a deeper and healthier root system.
- Tree roots do not “seek” water; they expand in girth and length where conditions are favorable for growth.
- Overwatering interferes with the roots’ ability to exchange oxygen and can lead to root rot and ultimate tree decline. Conversely, the root ball of a newly planted tree should never be allowed to totally dry out.

schematic designs + plant palettes

WHAT ARE THE SCHEMATIC DESIGNS + PLANT PALETTES?

The schematic plans show good examples of parkway layouts and plant options. If you are planning to adopt one of the five schematic designs, to use the plants included in these guidelines, and your plan does not otherwise depart from the standards, the City does not require a permit. You may “mix and match” plants from several schematic designs. If you do so, be sure to review the water needs, sun exposure, and growth habit of the plants to make sure they are compatible with each other.

The plans are diagrams to help with planning and plant selection. Actual dimensions and layout will vary. If you are planning changes to your parkway, you should take measurements and consider drawing a scaled plan on graph paper to help calculate the amount of plants and paving materials you will need.

PLANTS

The plants included here have low to moderate water needs, are relatively low-maintenance, are suitable for Culver City, and are appropriate for parkways. As with any plants, it is helpful to read more about them to learn their specific needs in terms of watering, pruning, etc. (see the Resources page at the end of this guide). The City is not responsible for any property damage, personal injury, or theft of plants or their fruits from the parkway.

The plants are shown as circles that represent the ultimate width of the plant; spacing plants this way gives them enough room to grow. Consider leaving some space between groups of plants to allow access across the parkway and for plant maintenance.

Remember to keep it simple! Using just a few different types of plants (as in these schematic plans) will help to create a more unified appearance and will simplify maintenance. You do not have to use all of the plants included in each palette.

ACCESS

Note that the step-out strip and accessway must be a uniform, walkable surface, which could include plants. Refer to the “Low Water Lawn / Meadow” palette for appropriate plant options.

Please note that the plant images are intended to illustrate the plant’s character; and not to illustrate proper plant layout or maintenance requirements, which must adhere to these guidelines.

1 CULVER CITY NATIVE GARDEN

schematic designs and plant palettes

These plants are native to the Culver City area. By planting these plants in your parkway, you will be helping to recreate, in a small but significant way, the historic ecosystems in this area and to create habitat for local species. Please note that these plants are probably not available at all nurseries and may require a visit to a nursery specializing in California native plants.

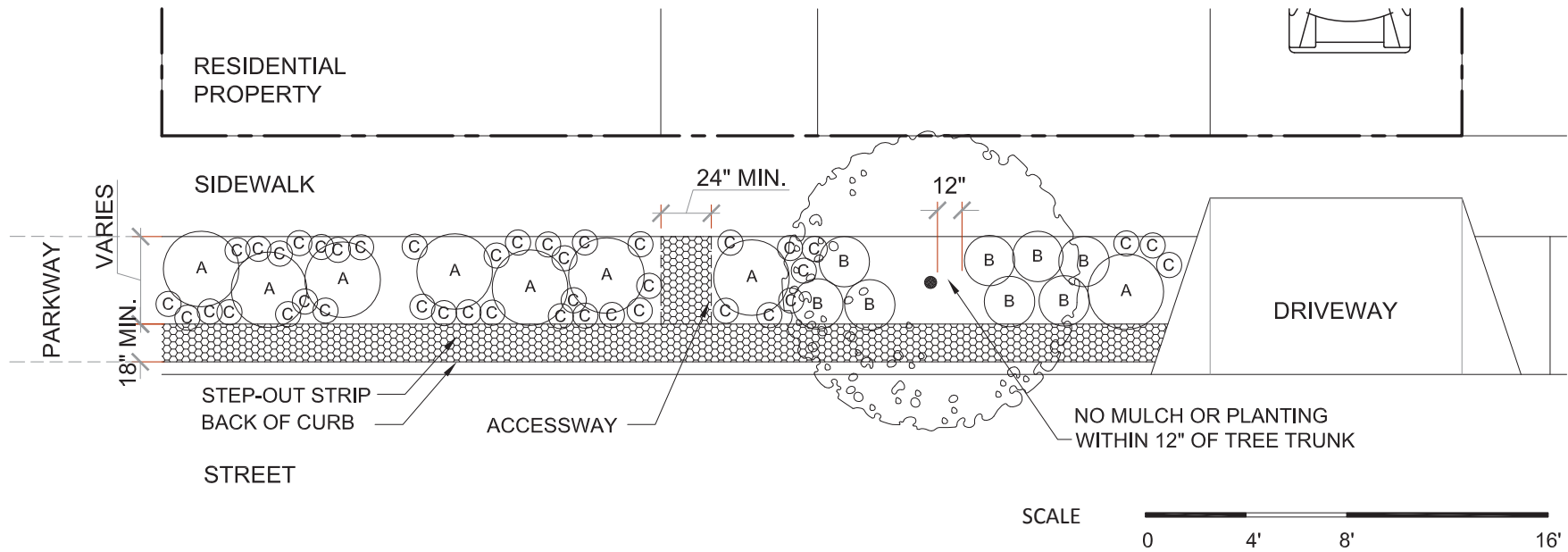

A SHRUBS FOR SUN



Baccharis pilularis
'Pigeon Point'
dwarf coyote bush



Epilobium canum
California fuchsia

A or B SHRUBS FOR SUN - PART SHADE



Eriogonum fasciculatum
California buckwheat



Corethrogyne (Lessingia)
filaginifolia 'Silver Carpet'
Silver Carpet aster



Mimulus aurantiacus
sticky monkeyflower

scientific name	common name	height	width	exposure	water	soil type	notes
<i>Baccharis pilularis</i> 'Pigeon Point'	Pigeon Point dwarf coyote bush	2'	6-8'	sun	low-mod	adaptable	Evergreen. Very drought-tolerant.
<i>Epilobium canum</i>	California fuschia	2'	4'	sun	low-mod	adaptable	showy red blooms in summer and fall
<i>Eriogonum fasciculatum</i> + cultivars	California buckwheat	varies with cultivar	varies with cultivar	sun-pt shade	low	adaptable	Great habitat plant for birds and butterflies. Some cultivars ok for clay soil
<i>Corethrogyne (Lessingia) filangifolia</i> 'Silver Carpet'	Silver Carpet aster	6"	3'	sun-pt shade	low-mod	adaptable	Silvery evergreen foliage, small lavender daisy-like flowers.
<i>Mimulus aurantiacus</i>	sticky monkeyflower	2-3'	3'	sun-pt shade	low	adaptable	Attracts birds and butterflies. Forage source for the Common Checkerspot and Buckeye butterflies
<i>Asclepias eriocarpa</i>	woolly pod milkweed, Indian milkweed, kotolo	1-3'	spread	sun-pt shade	low-mod	adaptable	Forage source for Monarch and Striated Queen butterflies
<i>Asclepias fascicularis</i>	narrow-leaved milkweed	< 4'	spread	sun-pt shade	mod	adaptable	Forage source for Monarch and Striated Queen butterflies, host for Monarch
<i>Sisyrinchium bellum</i>	blue-eyed grass	4-12"	6"	sun-pt shade	low-mod	adaptable, ok for clay soils	Summer dormant, can cut leaves down during dormancy, will grow new leaves with fall/winter rains. Butterfly plant
<i>Gilia capitata</i>	globe gilia	1-2'	1'	sun-pt shade	low-mod	adaptable	Easy to grow

C PERENNIALS



Asclepias eriocarpa
woolly pod milkweed

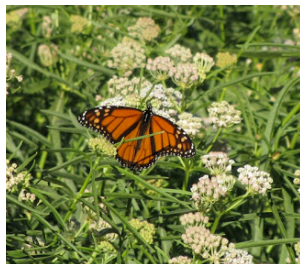

Asclepias fascicularis
narrow-leaved milkweed

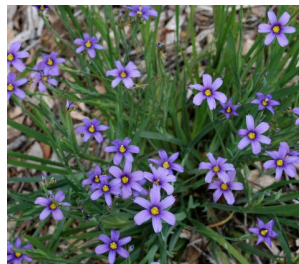

Sisyrinchium bellum
blue-eyed grass

ANNUALS



Gilia capitata
globe gilia

2 TRIED-AND-TRUE CALIFORNIA NATIVES

schematic designs and plant palettes

These plants are native to the state of California and have proven to be reliable in local gardens. By planting these plants in your parkway, you will be celebrating the seasonal beauty of California plants and will be helping to create important urban habitat for pollinators, butterflies, and birds.

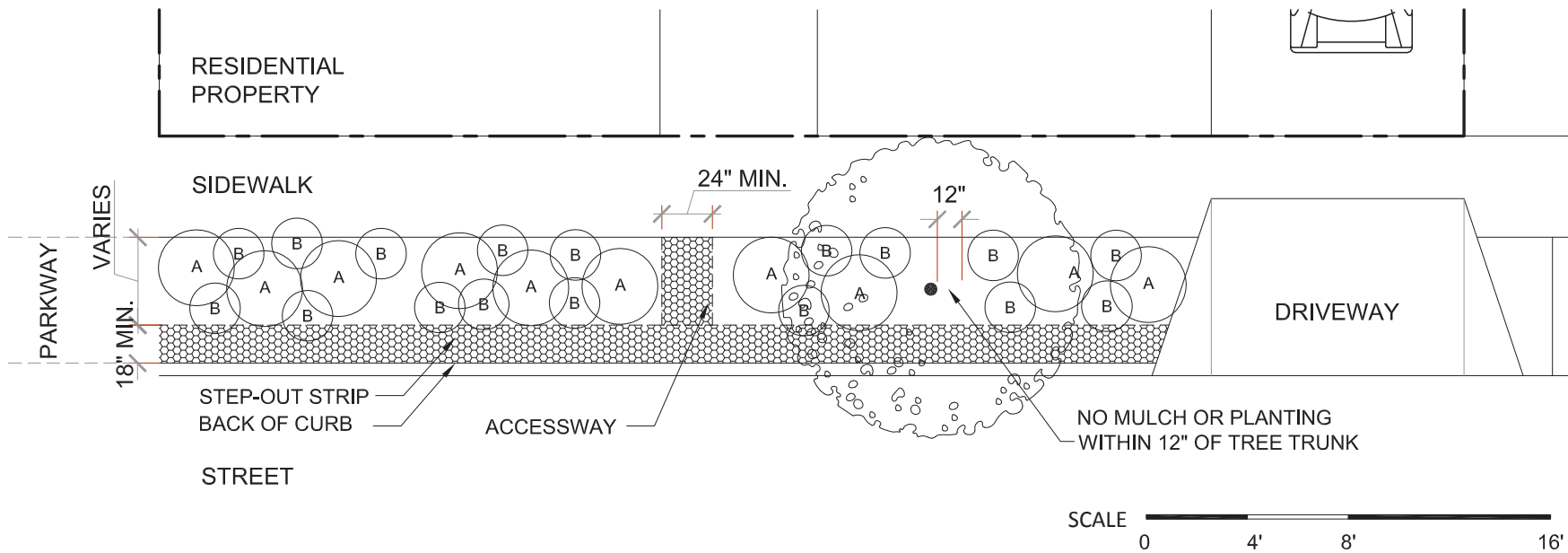

A SHRUBS

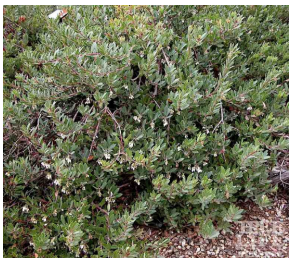

Arctostaphylos 'Pacific Mist'
Pacific Mist manzanita

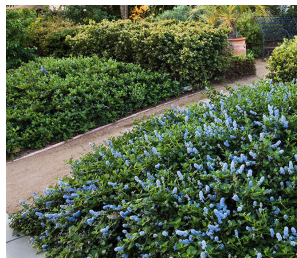

Ceanothus 'Yankee Point'
Yankee Point California lilac



Epilobium species
California fuchsia



Salvia 'Bee's Bliss'
Bee's Bliss sage

scientific name	common name	height	width	exposure	water	soil type	notes
<i>Arctostaphylos</i> 'Pacific Mist'	Pacific Mist manzanita	2'	5'	sun-pt shade	low-mod	well-draining	Attracts birds, butterflies. The first summer after planting, water 1-2 times per week, depending on the weather. Once established, reduce watering to once per month.
<i>Ceanothus</i> 'Yankee Point'	Yankee Point California lilac	3'	6-10'	sun-pt shade	low-mod	adaptable	Attracts birds, butterflies. Clay soil ok. Do not water frequently in summer (it can lead to root rot and brach die-back). Provide infrequent, deep irrigation.
<i>Epilobium</i> species (synonym: <i>Zauschneria californica</i>)	California fuchsia	select cultivar under 3'	2-3'	sun-pt shade	low-mod	adaptable	Recommended cultivars include 'Everett's Choice,' 'Ghostly Red,' 'Calistoga'. After first year, cut back to few inches when blooming complete (fall/winter) to encourage lush spring growth.
<i>Salvia leucophylla</i> 'Bee's Bliss'	Bee's Bliss sage	1-2'	2-5'	sun-pt shade	very low-low	well-draining	Benefits from occasional deep watering (not frequent watering) in the summer.
<i>Achillea millefolium</i> and cultivars	yarrow	6" if mown	2', spreads	sun	mod	adaptable, OK in clay	Flower stalks to 2' high, can be mown for lawn, fuzzy, fern-like leaf texture.
<i>Iris douglasiana</i>	Douglas iris	1'	2'	sun-pt shade	low-mod	well-draining, rocky, acidic	Attracts hummingbirds. Clay soil ok .
<i>Fragaria vesca</i>	wood strawberry	4-6"	spreads	part shade	low-mod	adaptable, OK in clay	Attracts birds and butterflies. Small, tasty fruit.
<i>Heuchera maxima</i>	island alumroot	2'	2'	pt-shade-shade	low-mod	adaptable	Delicate, wand-like pinkish white flowers in spring, attracts hummingbirds, Clay soil ok
<i>Eschscholzia californica</i>	California poppy	< 1'	< 1'	full sun	low	adaptable	California state flower. Grows best from seed, sow at start of rainy season in fall. Tends to reseed.

B PERENNIALS

ANNUALS



Achillea millefolium
yarrow

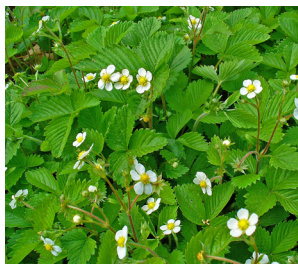

Fragaria vesca
wood strawberry



Heuchera maxima
island alumroot



Iris douglasiana
Douglas iris

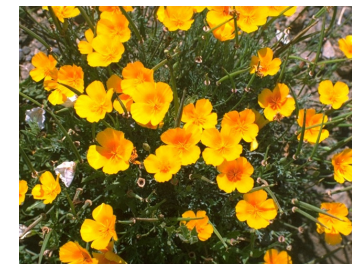

Eschscholzia californica
California poppy

3 MORE TRIED-AND-TRUE PLANTS FOR SOUTHERN CALIFORNIA

These plants are familiar favorites in Southern California gardens for their beauty, reliability, and low maintenance needs. These plants are well-suited to our climate and will attract birds, butterflies, and pollinators.

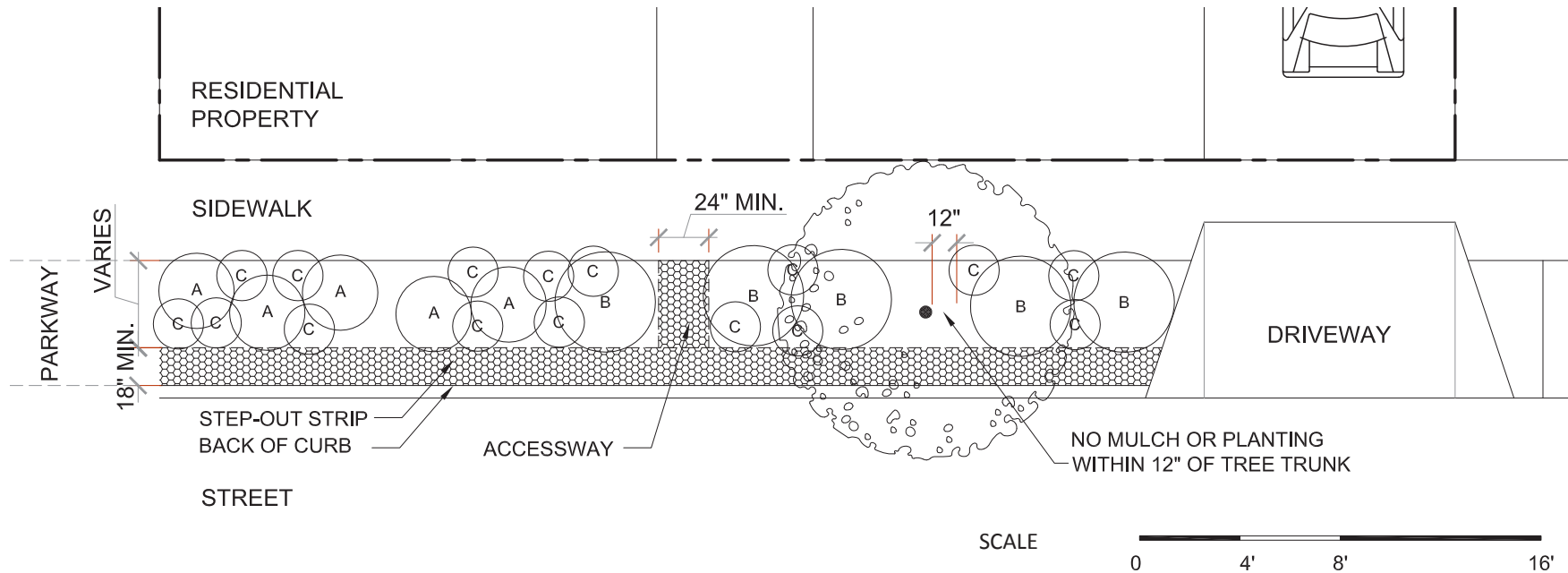

A UPRIGHT SHRUBS



Myrtus communis 'Compacta' dwarf myrtle



Lavandula stoechas Spanish lavender

B SPREADING SHRUBS

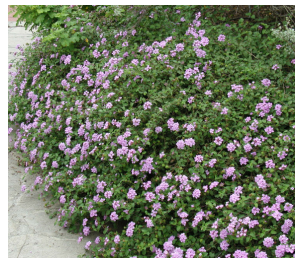

Lantana montevidensis purple trailing lantana



Lantana camara 'Gold Rush' Gold Rush lantana
Culver City's official flower



Rosmarinus 'Prostratus' prostrate rosemary

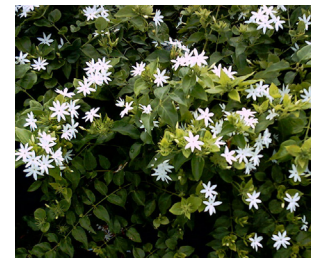

Trachelospermum jasminoides star jasmine

scientific name	common name	height	width	exposure	water	soil	notes
<i>Myrtus communis</i> 'Compacta'	dwarf myrtle	2-3' (keep under 30")	2-3'	sun	low	adaptable, well-draining preferred	Fragrant leaf, small white flowers.
<i>Lavandula</i> species	lavender	choose species under 30"	varies, 1.5-4'	sun	low-mod	prefers alkaline, well-drained / sandy soil	Several species and cultivars suitable for Southern California are available at nurseries
<i>Lantana</i> (various types)	Lantana	select types under 30"	varies, 2-8'	sun	low-mod	adaptable	Durable, low-maintenance plant. Many types are available in a range of colors
<i>Rosmarinus</i> species	rosemary	varies, 12-30"	varies	sun	low	adaptable, well-draining preferred	Select lower-growing types like 'Prostratus,' 'Collingwood Ingram,' 'Huntington Carpet'
<i>Trachelospermum jasminoides</i>	star jasmine	2'	space at 5'	sun-pt shade	mod	adaptable, well-draining preferred	This vine can be grown as a groundcover with some tip-pinching. Very fragrant white flowers.
<i>Nepeta</i> 'Walker's Low'	catmint	2-3' (keep under 30")	2-3'	sun-pt shade	low	adaptable, well-draining preferred	Fragrant grey-green leaves, attracts bees, butterflies, and birds. Flowers spring-summer, prune after initial flowering
<i>Thymus</i> species	thyme	varies, 1"-12"	varies, to 24"	sun-pt shade	low-mod	adaptable, well-draining preferred	Many species are appropriate, including <i>T. x citriodora</i> (lemon thyme), <i>T. serpyllum</i> (woolly thyme), and <i>T. vulgaris</i> (common thyme)

C PERENNIALS



Nepeta 'Walker's Low'
Walker's Low catmint



Thymus vulgaris 'Argenteus'
silver thyme



Thymus serpyllum
woolly thyme

4 LOW-WATER LAWN / MEADOW

schematic designs and plant palettes

This palette includes low-growing, walkable groundcovers that require significantly less water than conventional turf. As noted in the list on the facing page, some of these plants are very low (like *Dymondia margaretae*) while others have more texture (like *Festuca* species). *Dymondia* requires no mowing. Mowing is optional for the others; also, some may go dormant part of the year. The palette includes some plants that are native to California, noted with an (N). Consult with the plant nursery for detailed instructions about establishment and care. Note that the Step-Out Strip and Accessway can be planted with any of these species.

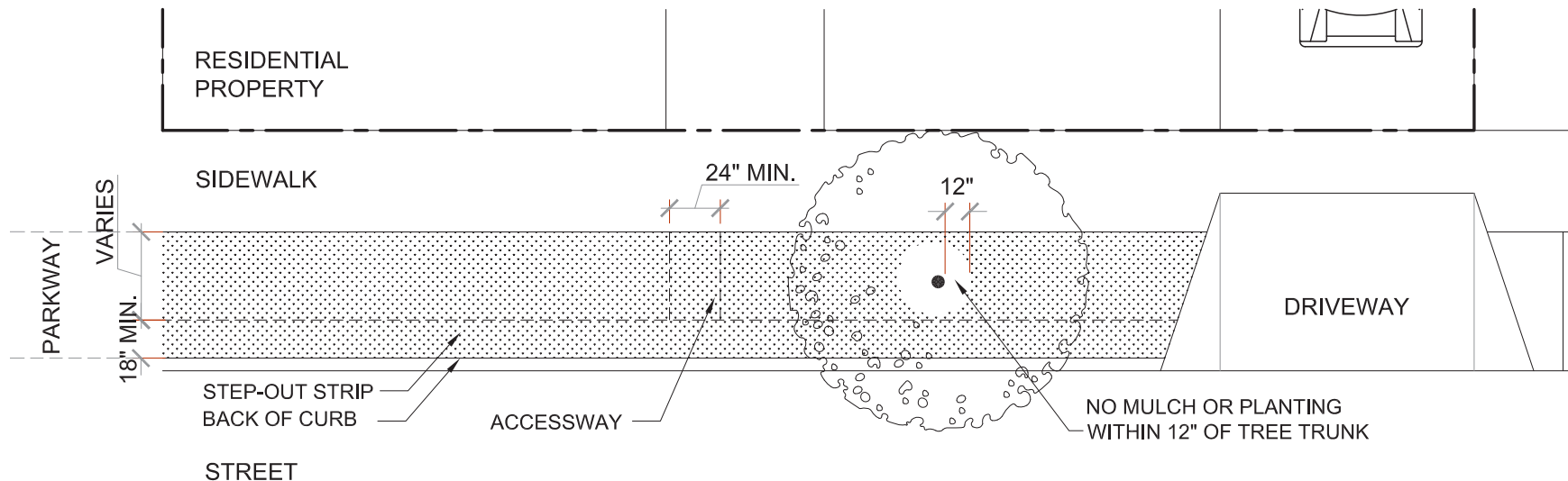

Note:
 --While seed or sod is getting established, you may temporarily mark off the parkway with low stakes and string or tape, so long as it does not pose a hazard



A NO MOWING REQUIRED



Dymondia margaretae
silver carpet

B MOWING REQUIRED FOR WALKABILITY



Achillea millefolium
yarrow, mown



unmown
(up to 2' tall)

C MOWING OPTIONAL



Agrostis pallens
bentgrass



Bouteloua gracilis
blue grama



Buchloe dactyloides 'UC Verde'
UC Verde buffalo grass

scientific name	common name	height	width	exposure	water	notes	recommended planting method
<i>Achillea millefolium</i> (N) and cultivars	yarrow	6"-1'	2', spreads	sun	mod	Can be mown for lawn, if left unmown will produce flower stalks to 2' high. Leaves have a soft, fern-like texture. Evergreen	seed
<i>Agrostis pallens</i> (N)	bentgrass	6"-1'	spreads	pt sun-pt shade	low-reg	Fine-texture, can be mowed, will stay green in summer with water	seed or sod
<i>Bouteloua gracilis</i> (N)	blue grama	6"-1'	6"-1'	sun	low	Mow to maintain as turf substitute. Umown, it is a beautiful ornamental grass. Winter dormant.	seed or plugs
<i>Buchloe dactyloides</i> 'UC Verde'	UC Verde buffalo grass	4-6"	spreads	sun	low-mod	Set plugs 12" apart. UC Verde is more heat-tolerant, with fine texture. Dormant in winter. Recommended planting time: Mar-Aug	plugs
<i>Carex pansa</i> (N)	dune sedge	12"	spreads	sun-lt shade	low-mod	Very similar to <i>C. praegracilis</i>	plugs, containers
<i>Carex praegracilis</i> (N)	clustered field sedge	12"	spreads	sun-lt shade	low-mod	Very similar to <i>C. pansa</i>	plugs, containers
<i>Dymondia margaretae</i>	silver carpet	2-3"	spreads by offsets to 20"	sun-lt shade	low	Silvery evergreen foliage, yellow flowers, spreads to form low mat	flats
<i>Festuca rubra</i> 'Molate' (N)	Molate red fescue	<1'	spreads	sun- shade	low-mod	Bunchgrass with beautiful, waving texture. Can be mowed if desired. Summer dormant. Recommended planting time: fall-winter	seed
Native Mow Free™ (sod) and Native Fescue Mix (seed)- <i>Festuca rubra</i> 'Molate', <i>F. idahoensis</i> , <i>F. occidentalis</i>	Native Mow Free™ and Native Fescue Mix	1'	spreads	sun- shade	low-mod	Available through S&S seeds, check for minimum order. Recommended planting time: fall-winter	seed or sod

(N) = native to California

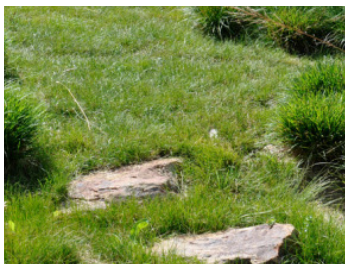

Carex pansa
dune sedge



Carex praegracilis
clustered field sedge



Festuca rubra 'Molate'
Molate red fescue



Native Mow Free™ /
Native Fescue Mix

5 EDIBLE GARDEN

schematic designs and plant palettes

Residents of multi-family dwellings are permitted to plant edibles in the parkway provided that they maintain the plants as outlined in these guidelines (respecting height limits and general good maintenance)*. Please refer to the standards section for the complete requirements regarding edible plants in parkways. Please note that most edible plants require full sun (at least 6 hours per day) and moderate to regular irrigation. These edible plants were selected because they are low-growing and do not have thorns.

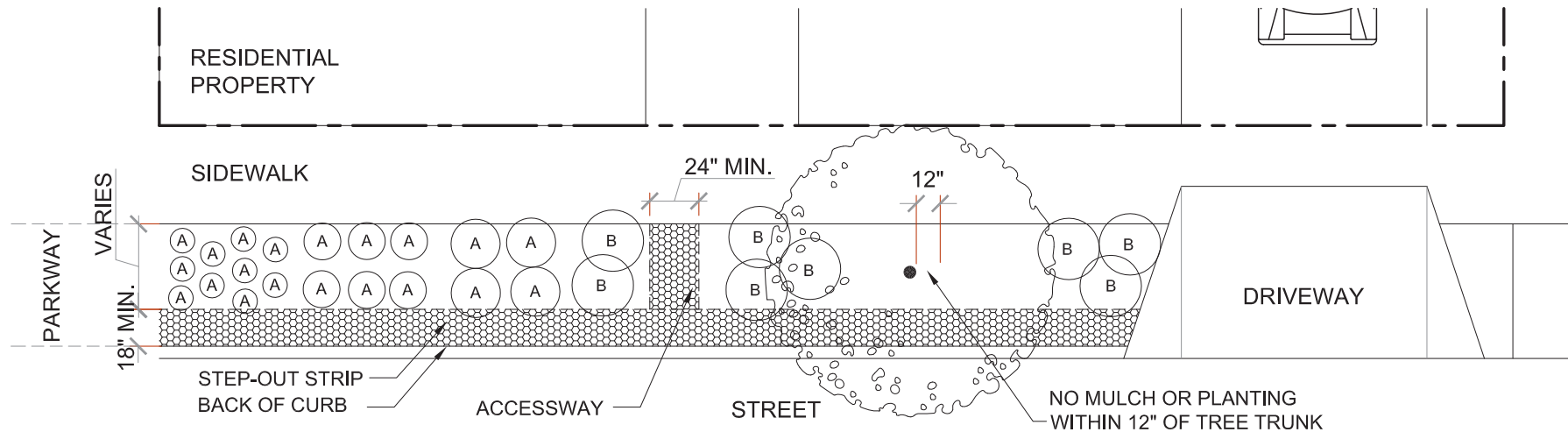

Plan Notes:

- Group several of the same type of plant together for easier maintenance and harvesting
- Grouping annuals together will make it easier to replace them at the end of the growing season
- Consider placing woody perennials next to walkways, since they are more durable. Consider planting scented plants there in order to enjoy the fragrance.
- Consider adding some flowering plants to attract pollinators (see Schematic Designs 1 + 2)
- For areas of part to full shade where edibles might not thrive, select shade-tolerant plants (see list of plants for shade)
- Keep in mind that you'll need space to walk between the plants for maintenance and harvesting



A ANNUALS



beets



bush beans



edamame



kale

*If a resident of a single-family dwelling does not have suitable space for edibles in their yard, they may apply for a permit to plant edibles in the parkway; they should include photos that clearly document the situation.

SPECIAL TOPIC

RAIN GARDENS

People in Culver City, Southern California, and beyond are increasingly aware of the need to conserve water, improve local water quality, and increase groundwater reserves. A rain garden is one strategy that contributes to reaching these goals. A rain garden is a planted landscape designed to collect rain water from impermeable surfaces (roofs, parking lots, driveways, and other paved areas) and either detain it (hold it temporarily), infiltrate it (let it sink into the ground), or a combination of both. Rain gardens can improve water quality by filtering it through soil and plants. They can also increase the reserves of ground water by directing storm water into the ground instead of over dirty streets, into pipes and ultimately, to the ocean.

Rain Gardens in Culver City

Culver City has created several rain gardens in order to improve local water quality and to increase groundwater levels. These rain gardens are adjacent to City buildings, the Creek, and residential landscapes; taken together, they treat rain water from several acres of impermeable surfaces. The City is developing a plan to construct rain gardens throughout the City as part of its program to meet urban runoff water quality requirements under a permit from the Regional Water Quality Control Board. These projects demonstrate the City's commitment to manage precious water resources and to improving water quality in Ballona Creek and Santa Monica Bay.



City Maintenance Operations Building
location: landscape in front of a building
Collects rain water from roof



Baldwin Ave. and Farragut Dr.
location: parkway
Collects rain water from street



Ballona Creek rain gardens
location: beside Creek
Collects rain water from roofs + parking lots



Lindblade St. and Sepulveda Blvd.
location: parkway
Collects rain water from adjacent roof

WHAT RESIDENTS CAN DO

special topic: rain gardens

To help improve local water quality and increase ground water reserves, residents might consider constructing a rain garden in their yard or parkway. Creating a rain garden requires thoughtful planning, design, construction, and maintenance. Please refer to the Resources page for several useful how-to guides.

Rain Gardens in Private Yards

A rain garden in your yard can capture and detain and/or infiltrate rain water from impervious surfaces like roofs, driveways, and patios. If your yard has a large, relatively flat area without mature trees and shrubs, and if the soil is well-draining, this could be a good option for you. You might direct downspouts to run into the rain garden and/or alter the grade of the ground to direct water from impervious surfaces. The total surface area from which you are capturing water will determine the size of the rain garden.

Parkway Rain Gardens

A rain garden in your parkway can capture and detain and/or infiltrate rain water from the street and/or from the sidewalk. A Culver City resident may apply for a permit to construct a rain garden in the parkway if the following conditions are met:

1. First, the adjacent property owner should call Dig Alert to locate any underground utility lines which will impact planning and design.
2. The plan drawing for the rain garden must be prepared and stamped by a landscape architect.
3. The plan drawing must demonstrate that the soil will absorb rain water so that there is no standing water 48 hours after a rain event.
4. The plan drawing must demonstrate that any existing trees and their root systems are protected.
5. The plan drawing must indicate measures to prevent soil erosion.
6. The plan must adhere to all other requirements for parkways (e.g., the inclusion of a step-out strip and accessway, 30" height limitations).
7. The plan and application must be submitted to the City's Public Works-Engineering Division for plan check review and permitting.
8. The rain garden must be constructed by a licensed C-27 Landscape Specialty Contractor with a Class A license (which allows concrete curb construction).
9. The rain garden must be maintained by the property owner.

5 additional plant lists

Plants for under Native Oaks

Plants for under Eucalyptus (or other large trees)

More Tried-and-True Plants for Southern California

Succulents

Plants for Shade

Prohibited Plants

PLANTS FOR UNDER NATIVE OAKS

NOTE: These plants are California natives with a good success rate in home gardens; these plants are also suitable for planting under other mature trees.

Native oak species are adapted to dry summers; watering them during the summer can lead to root rot and other problems. The plants on this list can thrive without summer water once established (after 1-2 years) and are able to compete with the root systems of mature trees. During the establishment period, be careful to provide only as much water as necessary so as to not damage the root systems of the oaks.

scientific name	common name	height	width	exposure	water	soil	notes
<i>Arctostaphylos</i> 'Pacific Mist'	Pacific Mist manzanita	2'	5'	sun-pt shade	low-mod	well-draining	Attracts birds, butterflies.
<i>Ceanothus</i> 'Yankee Point'	Yankee Point California lilac	3'	6-10'	sun-pt shade	low-mod	adaptable	Attracts birds, butterflies. Clay soil ok
<i>Fragaria vesca</i>	wood strawberry	4-6"	spreads	part shade	low-mod	adaptable, OK in clay	Attracts birds and butterflies. Small, tasty fruit
<i>Heuchera maxima</i>	island alumroot	2'	2'	pt shade-shade	low-mod	adaptable	Attracts hummingbirds. Clay soil ok
<i>Iris douglasiana</i>	Douglas iris	1'	2'	sun-pt shade	low-mod	well-draining, rocky, acidic	Attracts hummingbirds. Clay soil ok
<i>Mimulus aurantiacus</i>	sticky monkeyflower	2-3'	3'	sun-pt shade	low	adaptable	Attracts hummingbirds. Many cultivars available, with different flower colors
<i>Salvia</i> 'Dara's Choice'	Dara's Choice creeping sage	1-2'	3'	sun-pt shade	low	adaptable	Attracts birds, butterflies. Fragrant leaves
<i>Salvia mellifera</i> 'Terra Seca'	Terra Seca black sage	1-2'	6'	sun-pt shade	low	adaptable	Attracts birds, butterflies. Fragrant leaves. Clay soil ok



Arctostaphylos
'Pacific Mist'
Pacific Mist manzanita



Ceanothus 'Yankee Point'
Yankee Point
California lilac



Fragaria vesca
wood strawberry



Heuchera maxima
island alum root



Iris douglasiana
Douglas iris

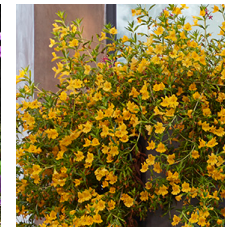

Mimulus aurantiacus
sticky monkeyflower



Salvia 'Dara's Choice'
Dara's Choice sage

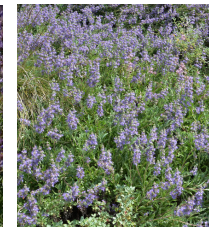

Salvia 'Terra Seca'
Terra Seca sage

PLANTS FOR UNDER EUCALYPTUS

NOTE: These plants are also suitable for planting under other mature trees.

Eucalyptus trees tend to have extensive root systems and to drop a large amount of leaves, which often makes it difficult for other plants to grow beneath their canopies. The plants listed here have been successful when grown under eucalyptus.

scientific name	common name	height	width	exposure	water	soil	notes
<i>Achillea millefolium</i> (N)	yarrow	6" if mown	2', spreads	sun	low-mod	adaptable, OK in clay	flower stalks to 2' high, can be mown for lawn, fuzzy, fern-like leaf texture
<i>Aloe</i> , various species	aloe	varies, approx 1-2'	varies, approx 1-3'	sun-pt shade	low		<i>A. striata</i> , <i>A. vera</i> , <i>A. maculata</i> , and <i>A. Johnson's 'Hybrid,'</i> and other types under 30" and without spines
<i>Arctostaphylos 'Pacific Mist'</i> (N)	Pacific Mist manzanita	2'	5'	sun-pt shade	low-mod	well-draining	Attracts birds, butterflies.
<i>Arctostaphylos 'Carmel Sur'</i> (N)	Carmel Sur manzanita	1-2'	6'	pt shade	low-mod	adaptable	Attracts birds, butterflies. Clay soil OK.
<i>Callistemon 'Little John'</i>	dwarf callistemon	3' (keep under 30")	3-5'	full sun-pt shade	low		Australia. Showy red bottlebrush-type blooms attract bees and butterflies
<i>Ceanothus 'Yankee Point'</i> (N)	Yankee Point California lilac	3'	6-10'	sun-pt shade	low-mod	adaptable	Attracts birds, butterflies. Clay soil ok
<i>Heuchera maxima</i> (N)	island alumroot	2'	2'	pt shade-shade	low-mod	adaptable	Attracts hummingbirds. Clay soil ok

(N) = native to California

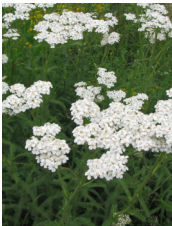

Achillea millefolium
yarrow



Aloe striata
coral aloe



Aloe vera
medicinal aloe



Aloe maculata
soap aloe



Aloe 'Johnson's Hybrid'



Callistemon 'Little John'
dwarf callistemon



Arctostaphylos 'Pacific Mist'
Pacific Mist manzanita

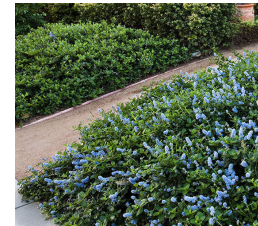

Ceanothus 'Yankee Point'
Yankee Point California lilac



Heuchera maxima
island alum root

SUCCULENTS

NOTE: Please note that some succulents are fragile and can be damaged by people or pets stepping on or past them.

scientific name	common name	height	width	exposure	water	notes
<i>Aeonium canariense</i>	no common name	1-2'	1', clumps to 2-3'	sun-pt shade	low-mod	<i>Aeonium</i> 'Alice Keck Park' is a good cultivar (possibly a hybrid of <i>A. canariense</i>)
<i>Aloe maculata</i>	soap aloe	1.5-2.5'	2'	sun-pt shade	low	
<i>Aloe striata</i>	coral aloe	1-2'	2'	sun	low	Blooms intermittently year-round
<i>Aloe vera</i>	medicinal aloe	2-3'	2-3'	sun-pt shade	low	
<i>Aloe</i> 'Johnson's Hybrid'	Johnson's Hybrid aloe	<1'	spreadin g	sun-shade	low	
<i>Calandrinia grandiflora</i> (syn. <i>Cistanthe</i>)	rock purslane	1'	2-3'	sun-shade	low	Very showy magenta flowers on tall, delicate stems, fall-spring
<i>Dudleya</i> spp. (N)	dudleya, chalk liveforever	<1'	1-2'	pt shade inland	low	<i>D. pulverulenta</i> , <i>D. brittonii</i> . Best to not water in summer. Avoid letting water collect in center.
<i>Echeveria</i> spp.	echeveria (includes Hens and Chicks)	varies	select species <30"	sun-pt shade	low-mod	Rosette-forming
<i>Kalanchoe</i> spp.	various	varies	varies	sun-shade	low	<i>K. marnieriana</i> , <i>K. luciae</i> , <i>K. tomentosa</i>
<i>Senecio</i> spp.	kleinia, blue chalksticks	varies, 1-3'	varies, 1-3', spreads	sun-pt shade	low	<i>S. mandraliscae</i> , <i>S. serpens</i> , <i>S. talinoides</i> , <i>S. vitalis</i> . Spreads (but not aggressively) to form lush "carpet"



Senecio mandraliscae
kleinia



Kalanchoe marnieriana
Marnier's kalanchoe

(N) = native to California



Aeonium canariense



Aloe maculata
soap aloe

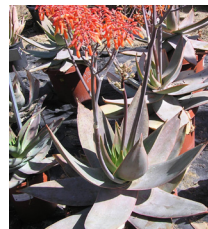

Aloe striata
coral aloe



Aloe vera
medicinal aloe



Aloe 'Johnson's Hybrid'



Calandrinia grandiflora
rock purslane



Dudleya pulverulenta
chalk liveforever

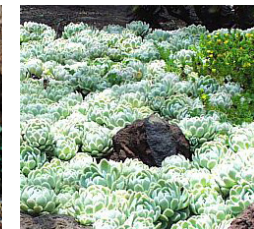

Echeveria elegans
elegant hens-and-chicks

PLANTS FOR SHADE

scientific name	common name	height	width	exposure	water	soil	notes
<i>Carex pansa</i> (N)	dune sedge	12"	spreads	sun-lt shade	low-mod	well-draining	Very similar to <i>C. praegracilis</i>
<i>Carex praegracilis</i> (N)	clustered field sedge	12"	spreads	sun-lt shade	low-mod	adaptable	Very similar to <i>C. pansa</i>
<i>Festuca rubra</i> 'Molate' (N)	Molate red fescue	<1'	spreads	pt sun-shade	low-mod	adaptable	Bunchgrass with beautiful, waving texture. Can be mowed if desired. Semi-evergreen to evergreen
<i>Fragaria vesca</i> (N)	wood strawberry	4-6"	spreads	part shade	low-mod	adaptable, OK in clay	Attracts birds and butterflies. Small, tasty fruit
<i>Heuchera maxima</i> (N)	island alumroot	2'	2'	pt shade-shade	low-mod	adaptable, OK in clay	Attracts hummingbirds. In addition to this California native, there are many other <i>Heuchera</i> species appropriate for our climate and shade
<i>Iris douglasiana</i> (N)	Douglas iris	1'	2'	sun-pt shade	low-mod	well-draining, rocky, acidic	Attracts hummingbirds. Clay soil ok
<i>Salvia spathacea</i> (N)	hummingbird sage	2'	spreads by offshoots	pt shade-shade	low-mod	adaptable, OK in clay	Fragrant foliage. Magenta flowers. Attracts birds (including hummingbirds) and butterflies. Tends to get powdery mildew and then recover on its own

(N) = native to California



Carex pansa
dune sedge



Carex praegracilis
clustered field sedge



Festuca rubra 'Molate'
Molate red fescue



Fragaria vesca
wood strawberry



Heuchera maxima
island alum root



Iris douglasiana
Douglas iris



Salvia spathacea
hummingbird sage

PROHIBITED PLANTS

This list includes invasive plants that are most likely to be found in nurseries or gardens. No invasive species are allowed in the parkway. Invasive plants have the potential to spread aggressively in the garden and beyond, where they can out-compete other plants and disrupt ecosystems. For the purposes of these guidelines, “invasive species” includes any plant on the current list of the California Invasive Plant Council’s “Don’t Plant a Pest” program (www.cal-ipc.org/landscaping/dpp - refer to Southern California region) OR in the Plant Right program’s invasive list for the South Coast region (www.plantright.org/regions/south-coast).

scientific name	common name	notes
<i>Carpobrotus edulis</i>	iceplant	This succulent groundcover forms dense mats that smother other plants. Note that several plants share the common name "Iceplant," so check the scientific name to be sure.
<i>Hedera species</i>	ivy	Several species of ivy are invasive in California. Since it is hard to distinguish from others that can be planted safely, all ivy species are not allowed in the parkways.
<i>Iris pseudacorus</i>	yellow flag iris	Can rapidly spread in moist areas and outcompete other plants.
<i>Nasella tenuissima</i>	Mexican feathergrass	Abundantly self-sows in the garden and can spread aggressively into natural areas.
<i>Pennisetum setaceum</i>	green fountain grass	Spreads aggressively into natural areas. Current research suggests that red varieties are not invasive (<i>P. setaceum</i> 'Rubrum')
<i>Vinca major</i>	periwinkle	Roots from trailing stems, allowing it to spread rapidly and outcompete other plants



Carpobrotus edulis
iceplant

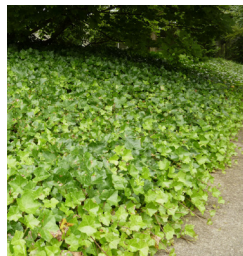

Hedera helix
ivy

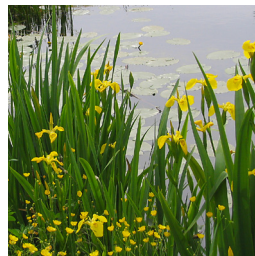

Iris pseudacorus
yellow flag iris



Nasella tenuissima
Mexican feather grass



Pennisetum setaceum
green fountain grass

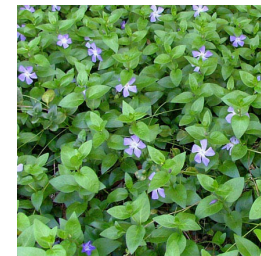

Vinca major
periwinkle

6 parkway examples



Here Molate red fescue (*Festuca rubra* 'Molate') is combined with native and non-native irises that provide beautiful leaf texture and seasonal blooms.



This parkway was seeded with yarrow (*Achillea millefolium*), which can be maintained as a walkable groundcover by mowing, or left to grow flower stalks.



Yankee Point California lilac (*Ceanothus* 'Yankee Point') is an evergreen, reliable native plant that attracts butterflies.

Note: This portion of the parkway is adjacent to a red curb, so no step-out strip is required here.

7 resources

Note: web addresses are included for informational purposes, but may change over time

CULVER CITY CONTACTS

For questions regarding trees, please contact the Maintenance Operations Division at (310) 253-6420.

For other parkway questions, please contact the Engineering Division at (310) 253-5600.

BOOKS

Bornstein, Carol, David Fross and Bart O'Brien. *California Native Plants for the Garden*. Los Olivos, CA: Cachuma Press, 2005.

Bornstein, Carol, David Fross and Bart O'Brien. *Reimagining the California Lawn: Water-conserving Plants, Practices, and Design*. Los Olivos, CA: Cachuma Press, 2011.

Brenzel, Katherine N., ed. *Sunset Western Garden Book*. 8th ed. Menlo Park, CA: Sunset Publishing Corporation, 2007.

Perry, Bob. *Landscape Plants for California Gardens: An Illustrated Reference of Plants for California Landscapes*. Claremont, CA: Land Design Publishing, 2010.

Perry, Bob. *Landscape Plants for Western Regions: An Illustrated Guide to Plants for Water Conservation*. Claremont, CA: Land Design Publishing, 1992.

Popper, Helen. *California Native Gardening: A Month-by-Month Guide*. Berkeley: University of California Press, 2012.

WATERING

"How to Keep Trees Alive in the Drought." Tree People, spring 2015 | blog.treepeople.org/treepeople-news/2015/04/dont-las-trees-casualties-drought#.VZLM7f1VhBc

Be Water Wise, Metropolitan Water District of Southern California | website includes a watering calculator based on your site and plant types www.bewaterwise.com/calculator.html

PLANTS AND PLANT INFORMATION

Note: this list is for informational purposes only and does not constitute an endorsement from the City of Culver City

Don't Plant a Pest! program | website and brochures show invasive plants commonly sold in nurseries, and gives suggested alternatives | www.cal-ipc.org/landscaping/dpp/

Plant Right | website shows invasive plants commonly sold in nurseries, and gives suggested alternatives | www.plantright.org/regions/south-coast

Greenlee and Associates | grass and meadow nursery experts | website with information about grasses + turf alternatives | retail (mail order, minimum order) | Brisbane + Watsonville, CA | www.greenleeandassociates.com/

Inner Gardens | local retail nursery | 5838 Perry Dr, Culver City, CA 90232
Phone: 310-838-8378 | <http://www.innergardens.com/plant-nursery>

Las Pilitas Nursery | native plants | retail (in-person and mail order) | Santa Margarita and Escondido, CA | www.laspilitas.com

Rolling Greens | local retail nursery with large selection | retail (in-person only) | Culver City, CA | rollinggreennursery.com/culver-city/

San Marcos Growers | Mediterranean climate plants | Goleta Valley, CA | wholesale only, great online plant information | www.smgrowers.com

S&S Nursery | mostly native CA seeds & sod | retail (mail order, minimum order) | Carpinteria, CA | www.ssseeds.com

Theodore Payne Nursery | native CA plants and seeds | retail (in-person only) | www.theodorepayne.org

RAIN GARDEN HOW-TO

- Rain Gardens: Santa Clara Valley Urban Runoff Prevention Program | www.scvurppp-w2k.com/pdfs/1213/BASMAA_Rain_Garden_Fact_Sheet_11_26_12_CORRECTED_online_ver.pdf